

Dental & Holloware Instruments Catalogue



www.salim-group.com

**MANUFACTURERS, IMPORTERS & EXPORTERS OF
DENTAL & SURGICAL INSTRUMENTS**

SALIM Group Of Industries

P.O.Box: 2561, Sialkot -Pakistan.

Tel : 0092-52-4597649

Fax : 0092-52-4587056

E-Mails: salimgroup@brain.net.pk

: malikshahidsaleem@hotmail.com

Web : www.salim-group.com

ABOUT



Presentamos con orgullo la nueva edición del catálogo para la moderna cirugía y odontología, con la esperanza que ofrezca un servicio más amplio a nuestros favorecedores.

Hemos incluido en esta edición tantos instrumentos como fue posible.

Estamos prestando un servicio competente, cortés y confiable del instrumental que Uds. reciben.

“Salim-Group” está respaldado por una amplia y total garantía, que cubre la calidad del material usado, así como su cuidadosa manufactura.

Nos esforzamos en usar las técnicas más avanzadas, según se aplican en los países más desarrollados, en la fabricación de instrumental standarizado.

Finalmente expresamos profundo agradecimiento a todos nuestros clientes amigos y relacionados, y hacemos una solemne promesa por mantener la confianza que nos han conferido, estableciendo un mayor esfuerzo en superar nuestra labor, con toda eficacia, y sobre todo, mantener la calidad de nuestros instrumentos.

CONTENTS

Articulator	110-111
Amalgam Carriers	88
Amalgam Carvers	66 - 67
Blowers, Napkin & Film Holder	90
Bone Ronçeurs	20
Crown Instruments & Removers & Plaster Cutting Pliers	92 - 94
Cavity Preparation Instruments	68
Chisels and Gouges	51
Excavators	69 - 71
Endodontic Instruments	
Explorers, Probes	58 - 61
Forceps	
English Pattern Forceps	1 - 11
Root Fragment Forceps	12
For Children with spring	13
American Pattern Forceps	14 - 18
Root Splinter Forceps	19
Haemostatic Forceps	38 - 39
Sponge & Dressing Forceps	40
Sterilizing Forceps	43
Root Splinter Forceps	19
Filling Instruments Plastic Filling Instrument	62 - 66
Gracey Curettes & Scalers	75 - 81
Handles	
Handles For Mouth Mirrors	55
Scalpel Handle	56
Handle Reference Guide	57
Matrix Retainers	91
Needle Holder	41 - 42
Orthodontic Instruments	33
Pliers for Orthodontics & Prosthetics	28-29-30-31
Periodontia Instruments	76
Pliers Tissue, Cotton & Dressing	53 - 54
Root Elevators	21 - 27
Retractors Raspatories & Elevators	44 - 50
Rubber Dam Instruments	52
Rubber Dam Clamps	105
Scissors	33 - 37
Spatula	
Cement Spatulas	82
Spatula (Plaster & Alginate)	87
Syringes	
Cartridge & Water Syringe	89 - 90
Towel Clamps & Skin Hook	44
Holloware	104-6-7-8-9
Impression Trays	95 - 101
Wax & Modelling Carvers	83 - 85
Wax Knives	86

EXTRACTING FORCEPS ENGLISH PATTERN

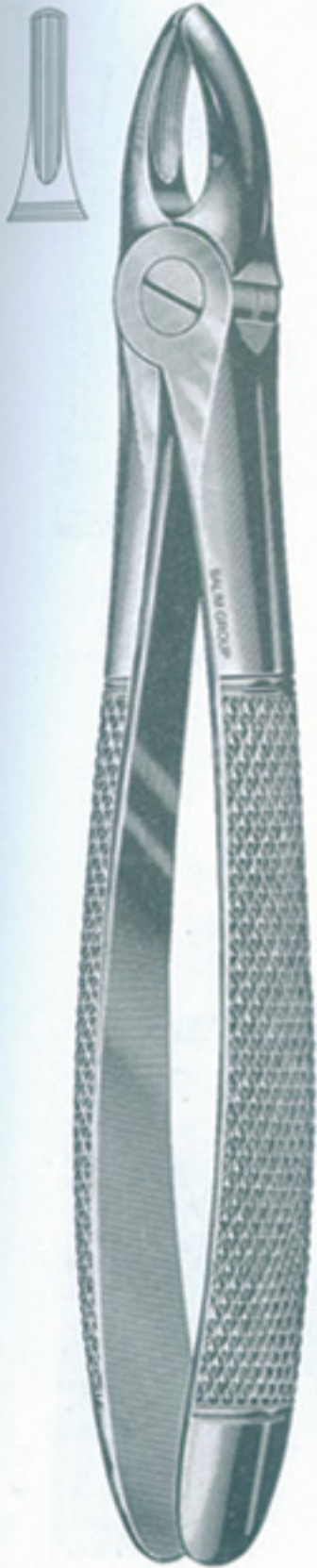

786-101
Fig.1
Upper centrals
& canines



786-102
Fig.2
Upper laterals
& bicuspids



786-103
Fig.3
Upper incisors
& canines

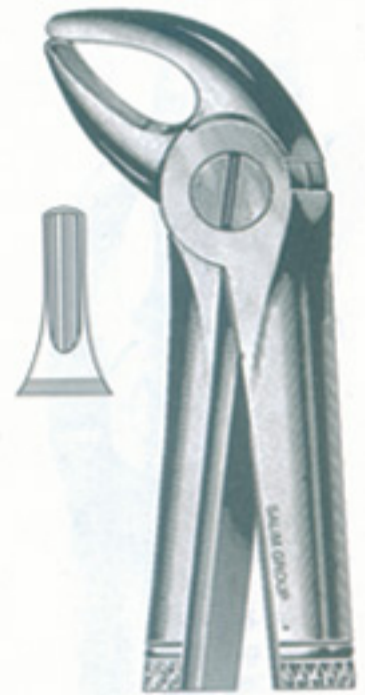

786-104
Fig.4
Lower incisors
& Canines

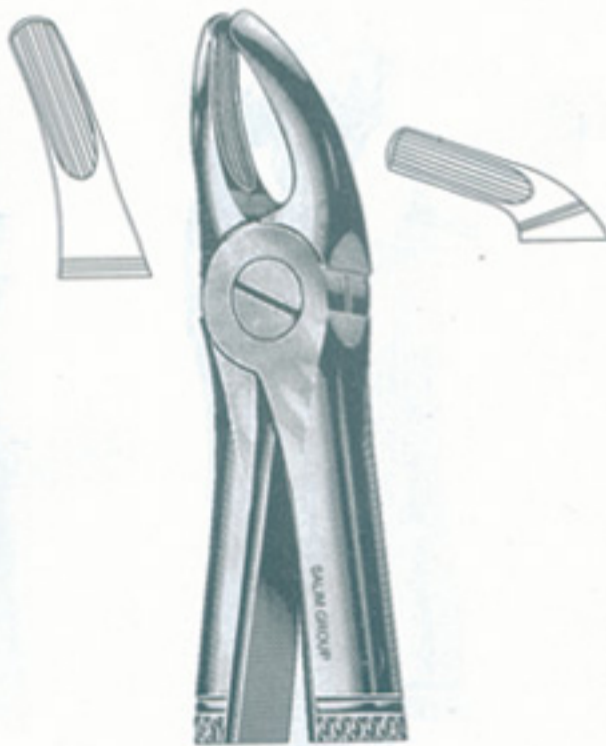

786-105
Fig.7
Upper primolars



786-106
Fig.8
Lower primolars



786-107
Fig.13
Lower primolars



SALIM
Group Of Industries

EXTRACTING FORCEPS ENGLISH PATTERN



786-108
Fig.17
Right upper molars

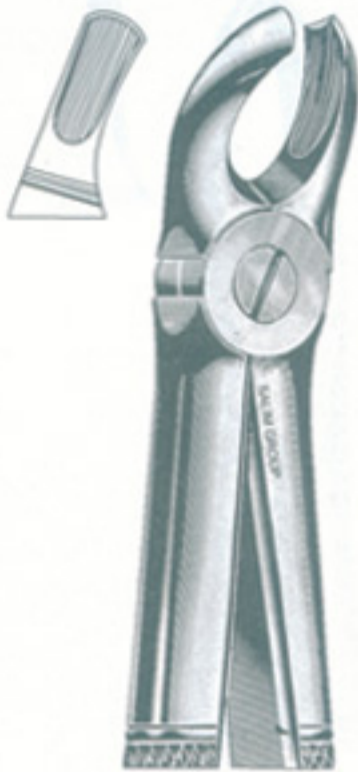

786-109
Fig.18
Left upper molars

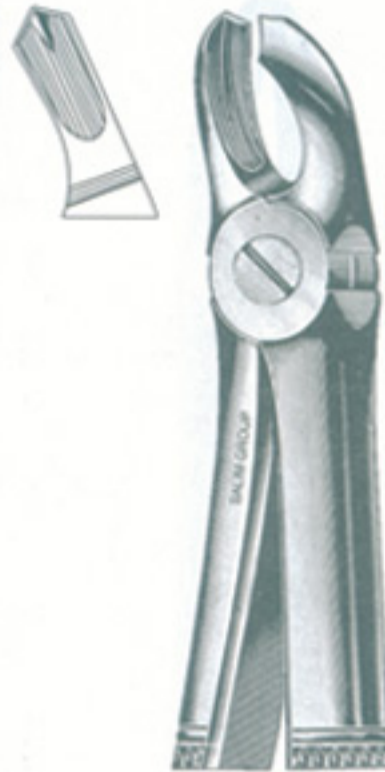

786-110
Fig.18A
Upper molars



786-111
Fig.19
Upper wisdoms



786-112
Fig.20
Lower wisdoms

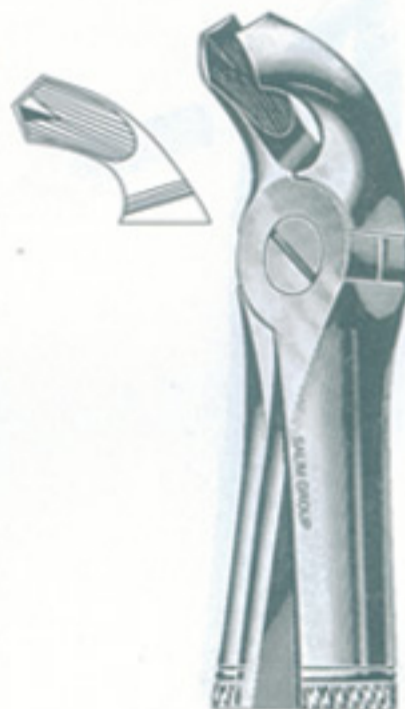

786-113
Fig.21
Lower molars

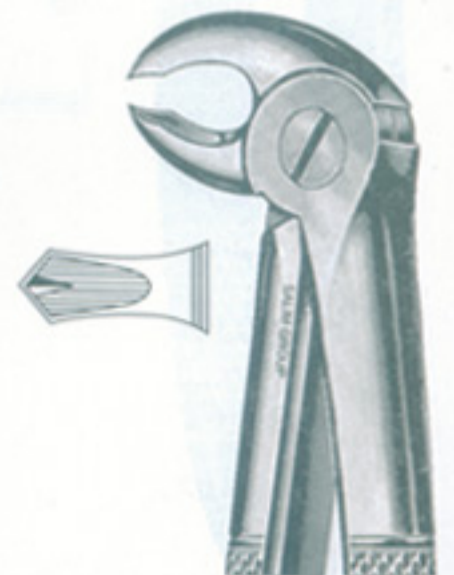

786-114
Fig.22
Lower molars
Hawk's bill

EXTRACTING FORCEPS ENGLISH PATTERN



786-115
Fig.23
Right lower molars



786-116
Fig.24
Left lower molars



786-117
Fig.29
Upper roots
& incisors



786-118
Fig.29N
Roots of upper
incisors

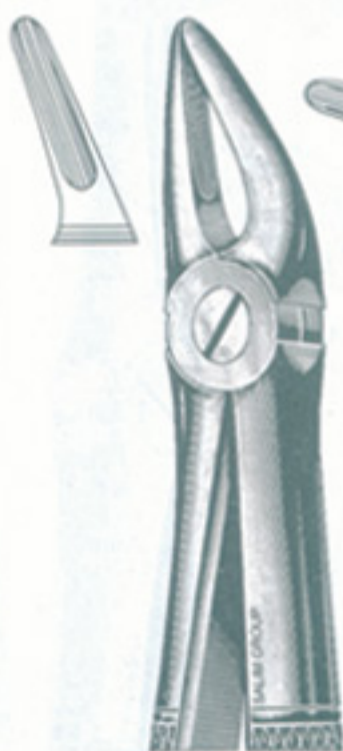

786-119
Fig.30
Upper roots &
incisors

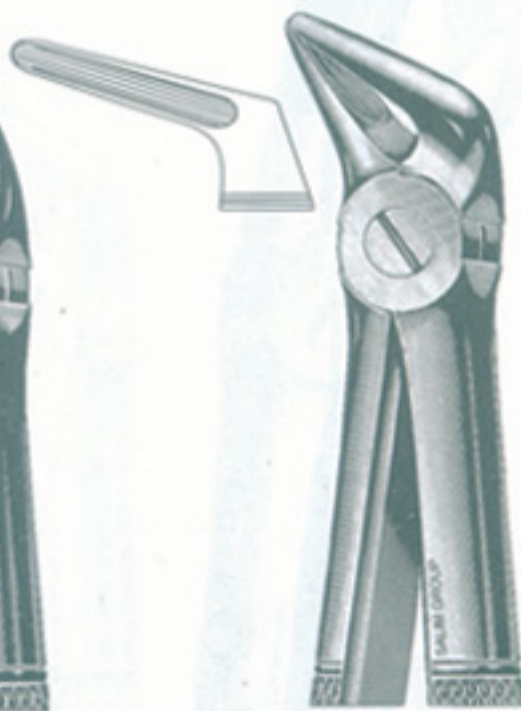

786-120
Fig.31
Lower roots



786-121
Fig.32
Lower molars



SALIM
Group Of Industries

EXTRACTING FORCEPS ENGLISH PATTERN

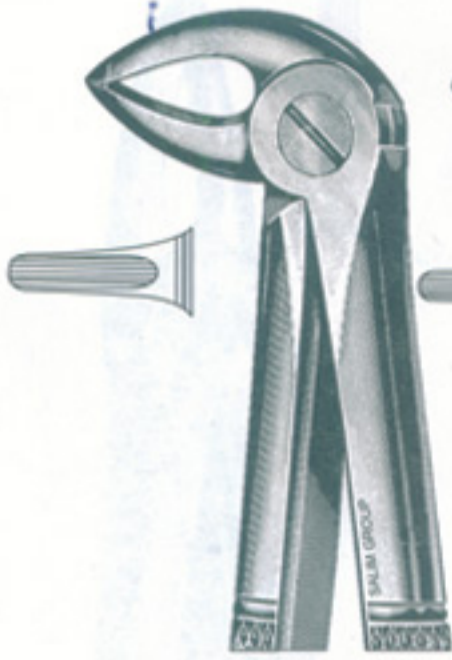

786-122
Fig.33
Lower roots

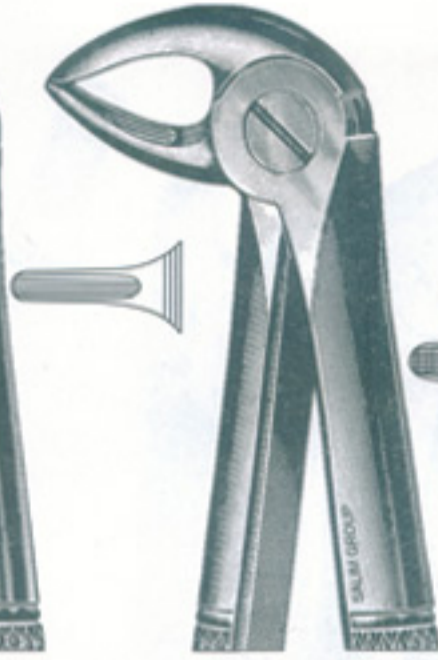

786-123
Fig.33A
Lower roots

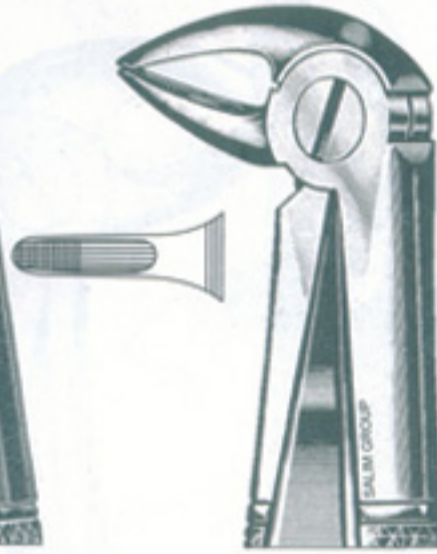

786-124
Fig.33C
Lower roots

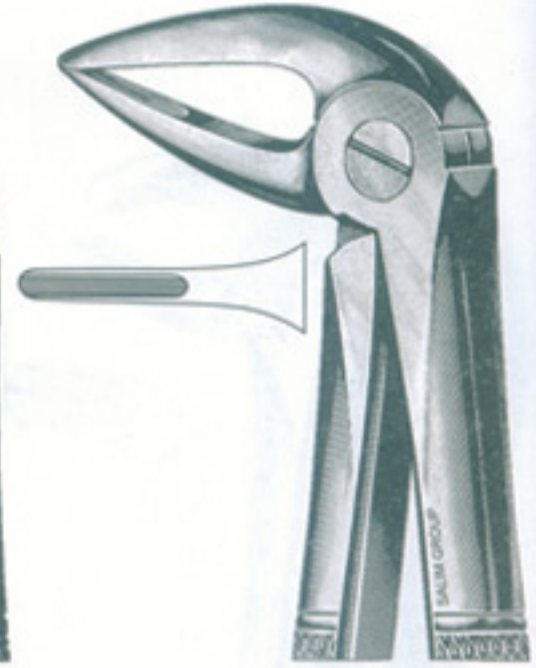

786-125
Fig.33M
Lower roots
with long beak

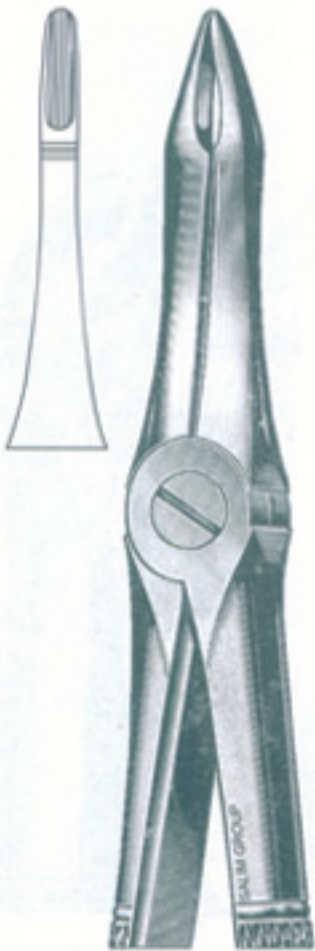

786-126
Fig.41
Upper roots

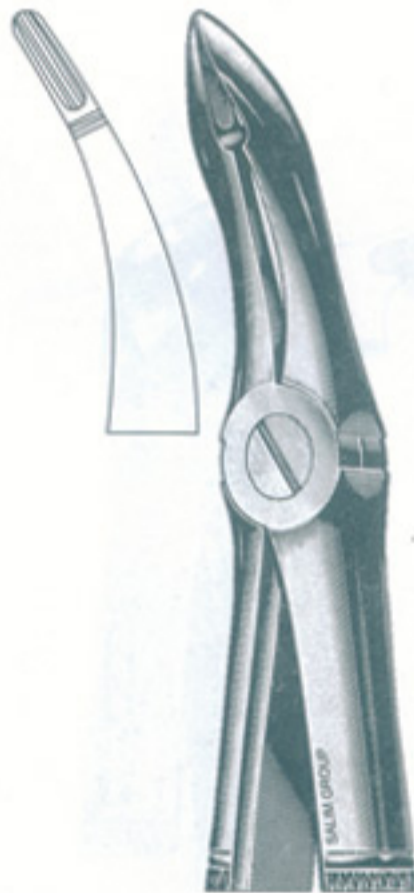

786-127
Fig.44
Upper roots

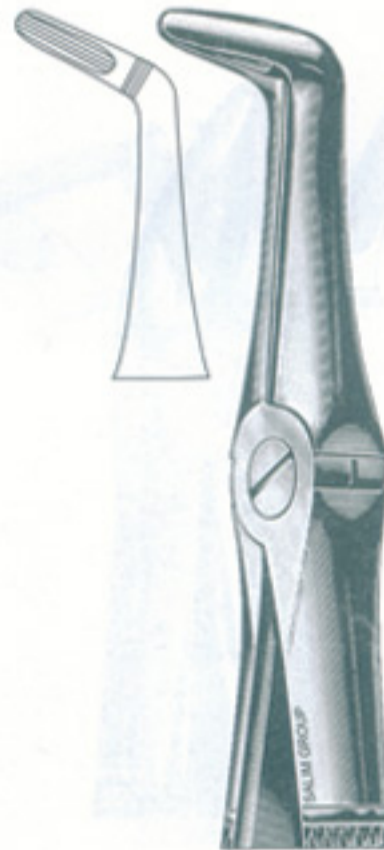

786-128
Fig.45
Lower roots

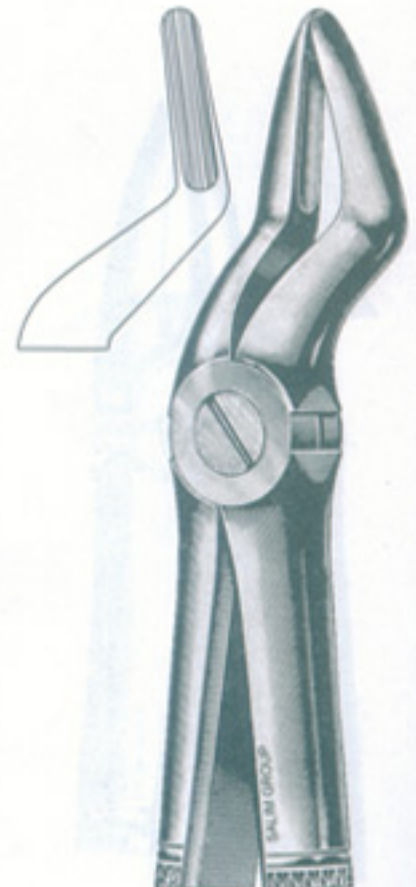

786-129
Fig.51
Upper roots

EXTRACTING FORCEPS ENGLISH PATTERN



786-130
Fig.51A
Upper roots
narrow beak

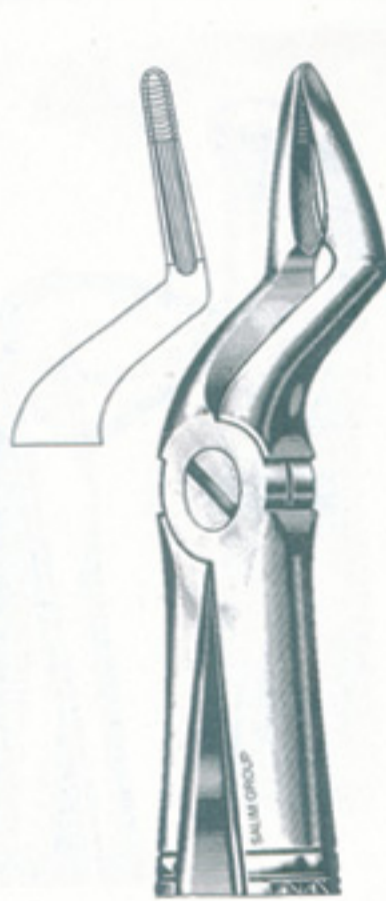

786-131
Fig.51C
Upper roots

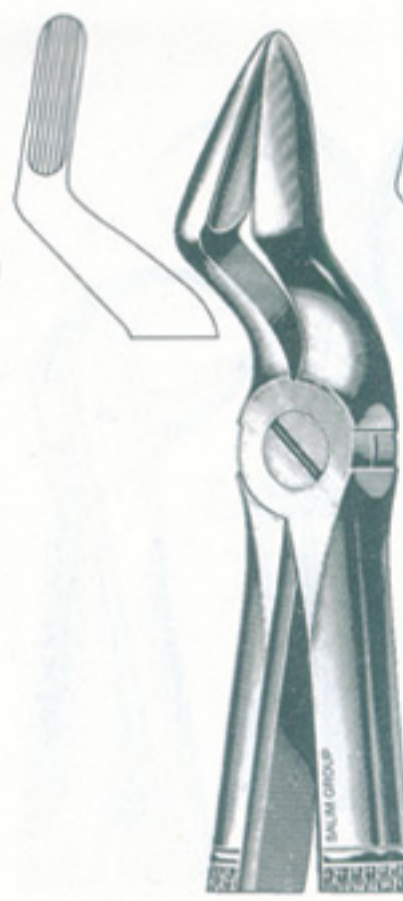

786-132
Fig.52
Upper roots & canines
with wider beak

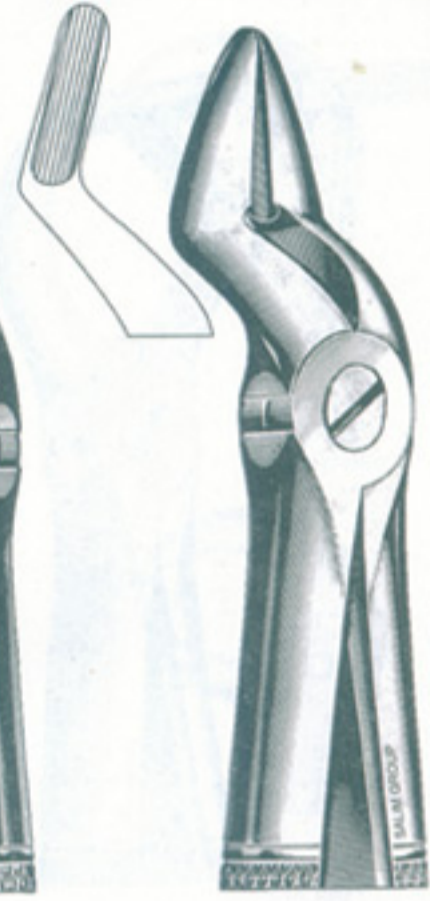

786-133
Fig.52A
Upper teeth &
resection



786-134
Fig.55
Separating upper
molars roots



786-135
Fig.56
Separating lower
molars roots

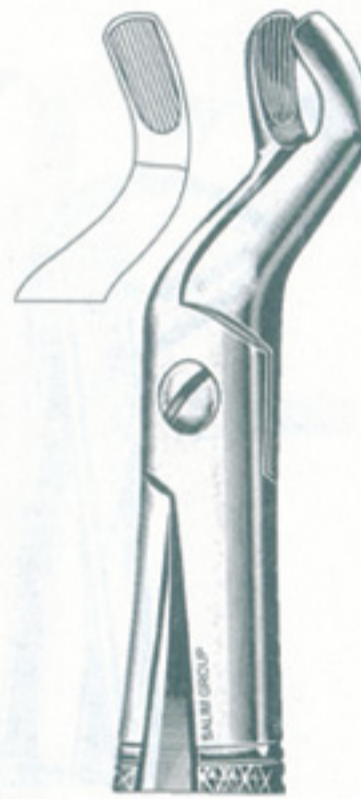

786-136
Fig.67
Upper wisdoms

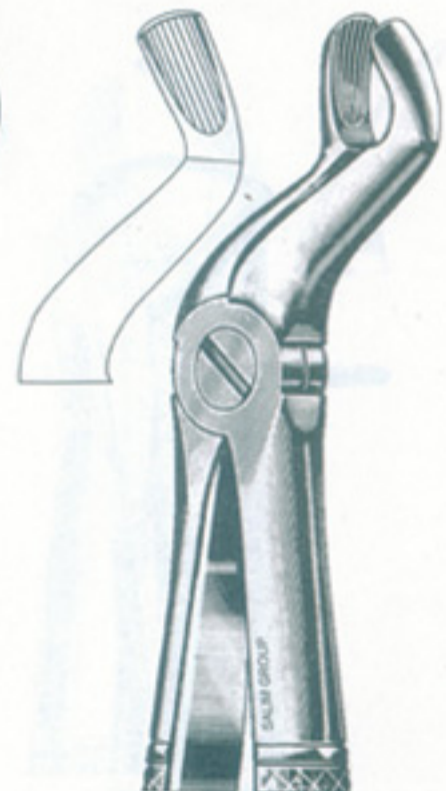

786-137
Fig.67A
Upper wisdoms



SALIM
Group Of Industries

EXTRACTING FORCEPS ENGLISH PATTERN

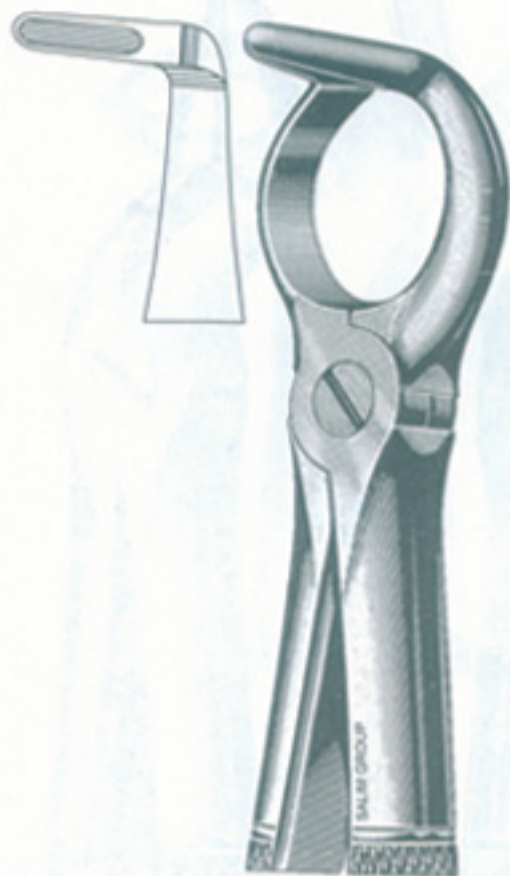

786-138
Fig.68
Lower roots

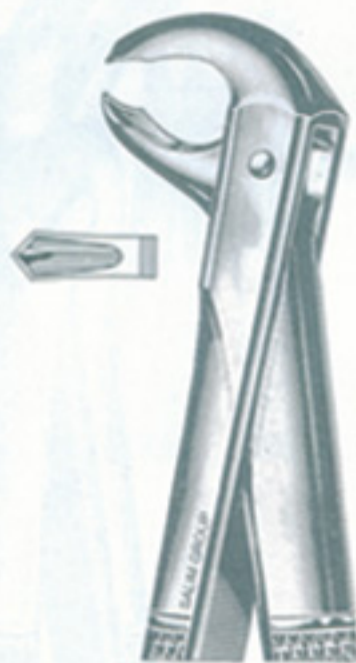

786-139
Fig.73
Lower molars
(Hawk's bill)

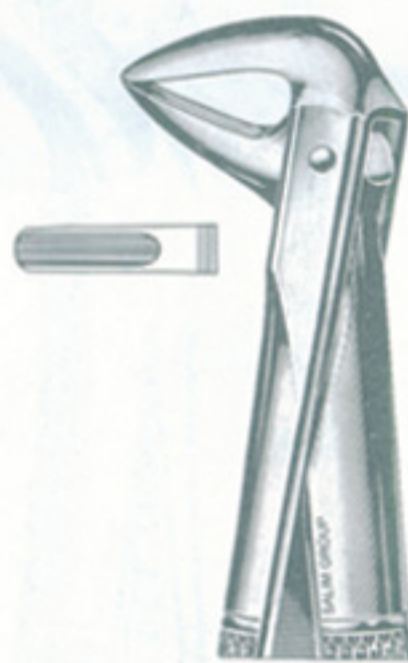

786-140
Fig.74
Lower incisors
& roots



786-141
Fig.74M
Lower incisors
& roots

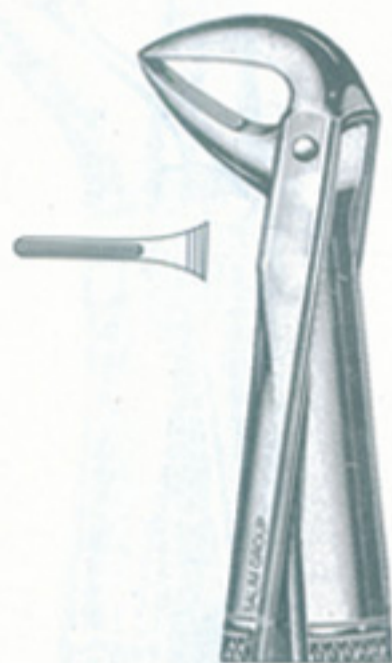

786-142
Fig.74N
Lower incisors
& roots

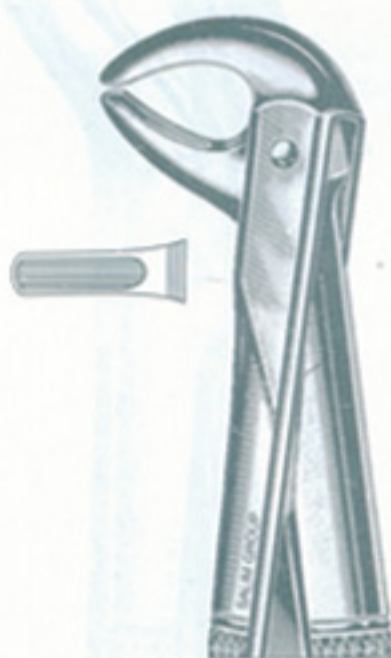

786-143
Fig.75
Lower premolars
& canines



786-144
Fig.76
Upper roots



786-145
Fig.76N
Upper roots
(narrow beak)

EXTRACTING FORCEPS ENGLISH PATTERN

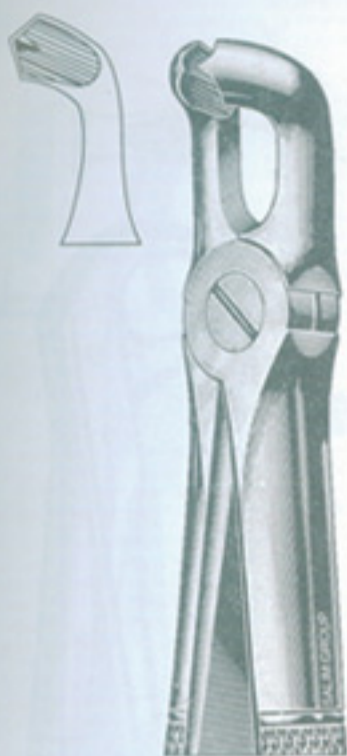

786-146
Fig.79
Lower wisdoms



786-147
Fig.79A
Lower wisdoms



786-148
Fig.86A
Lower molars



786-149
Fig.86B
Lower molars



786-150
Fig.86C
Lower molars

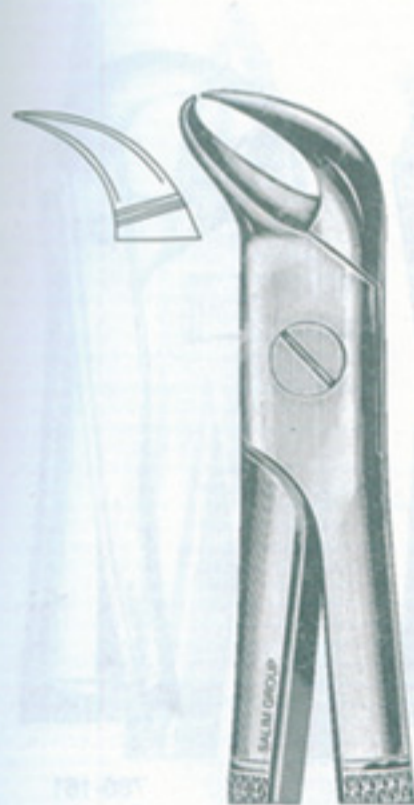

786-151
Fig.87
Cowhorn beak

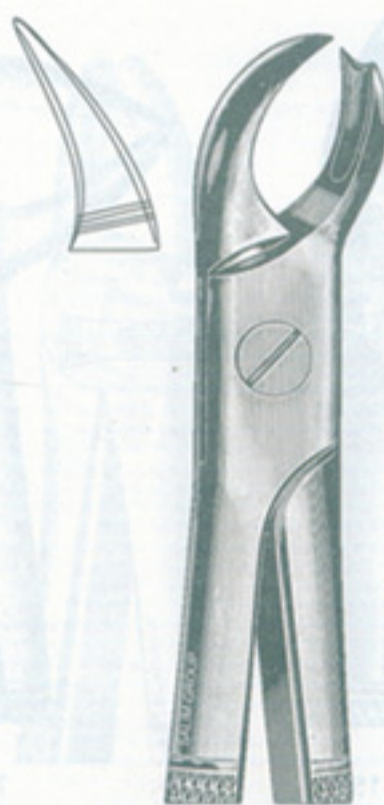

786-152
Fig.89
Right upper molars

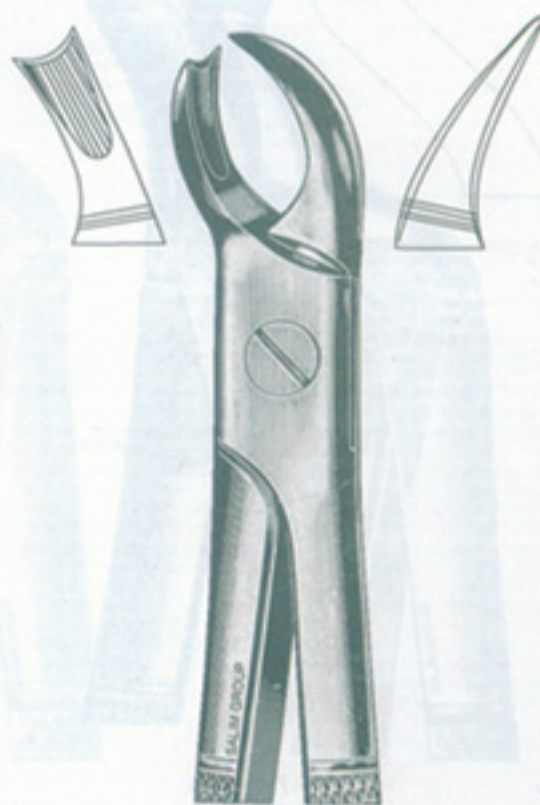

786-153
Fig.90
Left upper molars



SALIM
Group Of Industries

EXTRACTING FORCEPS ENGLISH PATTERN

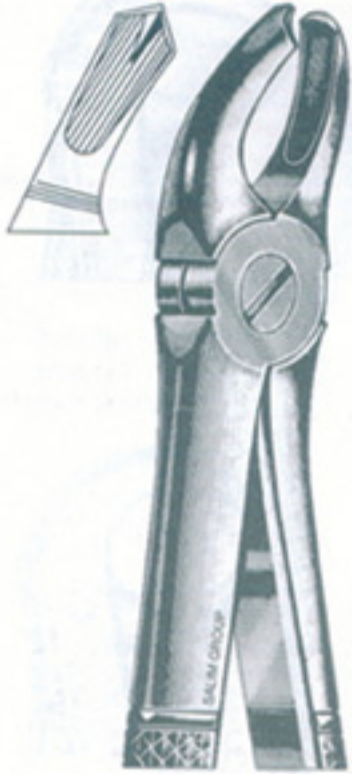

786-154
Fig.94
Right upper molars

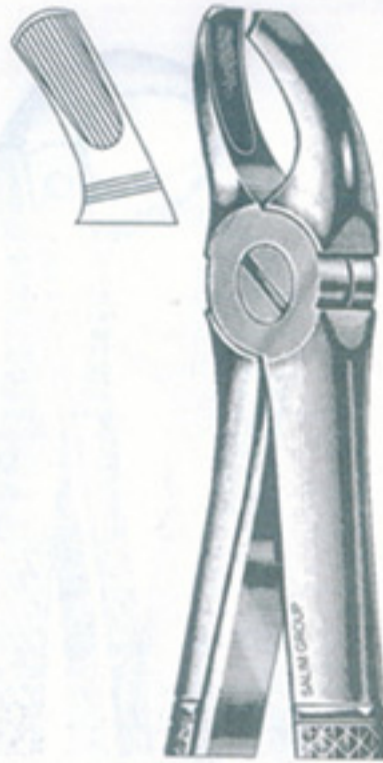

786-155
Fig.95
Left upper molars

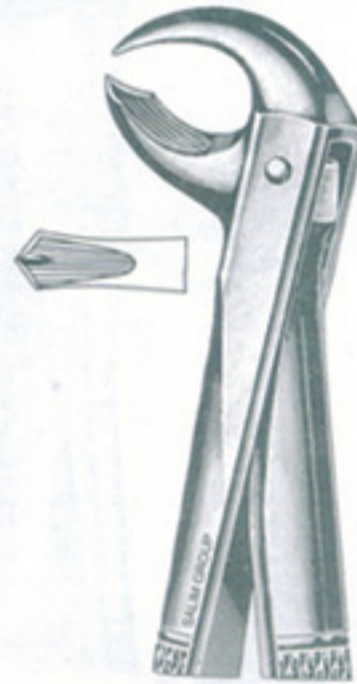

786-156
Fig.99
Lower molars
(broken-down)



786-157
Fig.99 1/4
Lower molars
(broken-down)

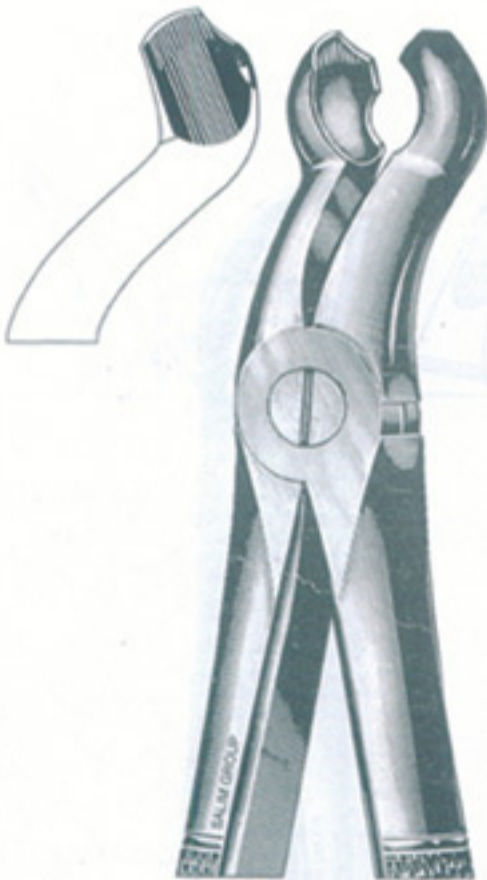

786-158
Fig.121
Upper wisdoms



786-159
Fig.136
Upper centrals
& roots

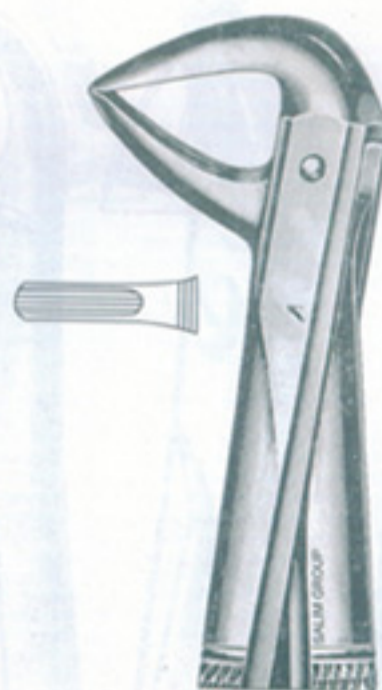

786-160
Fig.137
Lower centrals
& roots

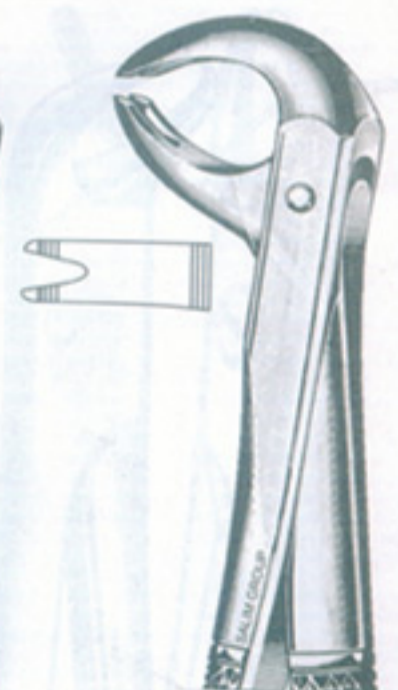

786-161
Fig.167
Universal pincer
for lower teeth
molars & premolars

EXTRACTING FORCEPS ENGLISH PATTERN

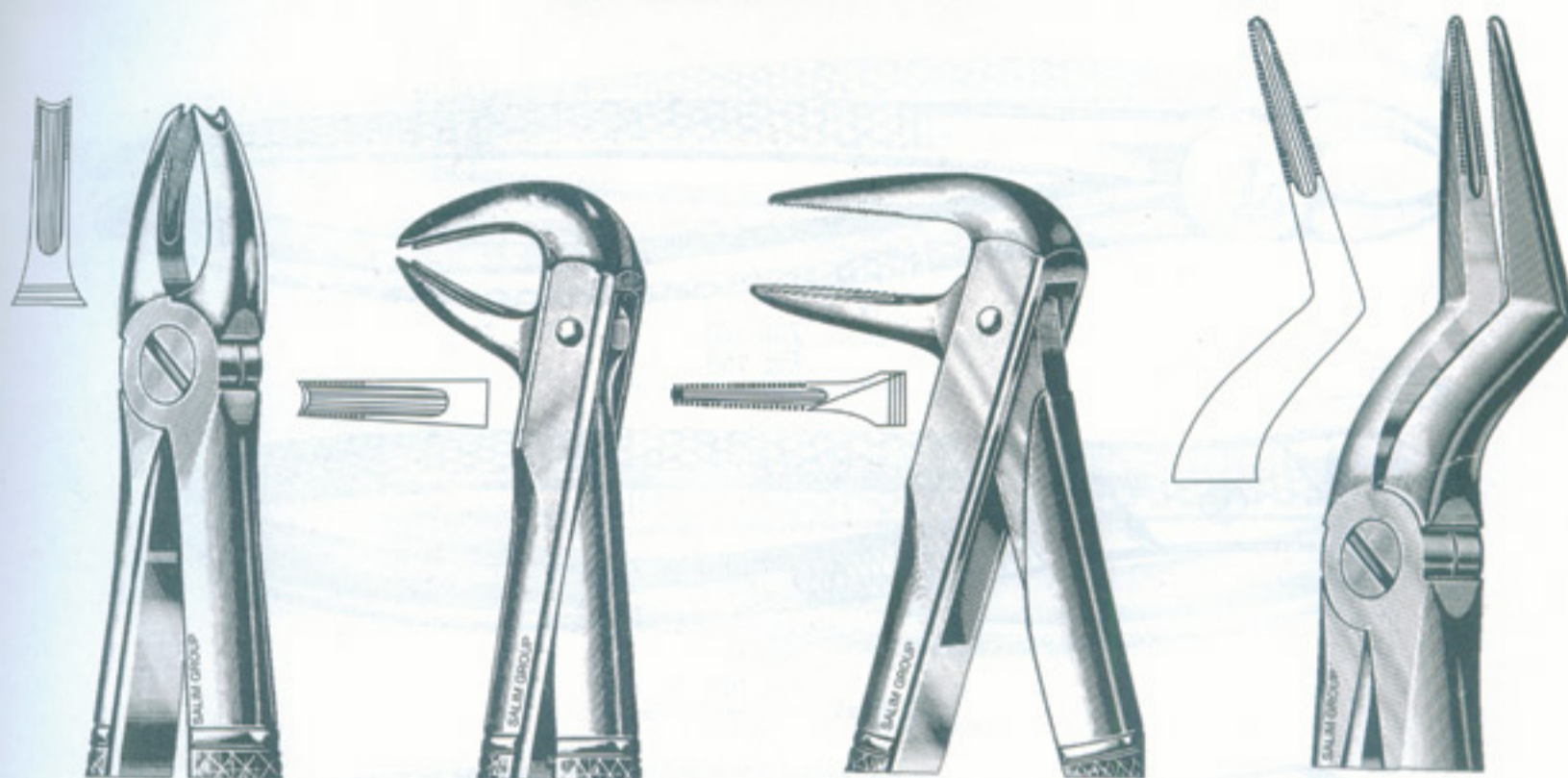

786-162
Fig.168
Upper canines

786-163
Fig.169
Lower canines
& premolars

786-164
Fig.233
Lower roots
(parallel beaks)

786-165
Fig.235
Upper roots
(parallel beaks)

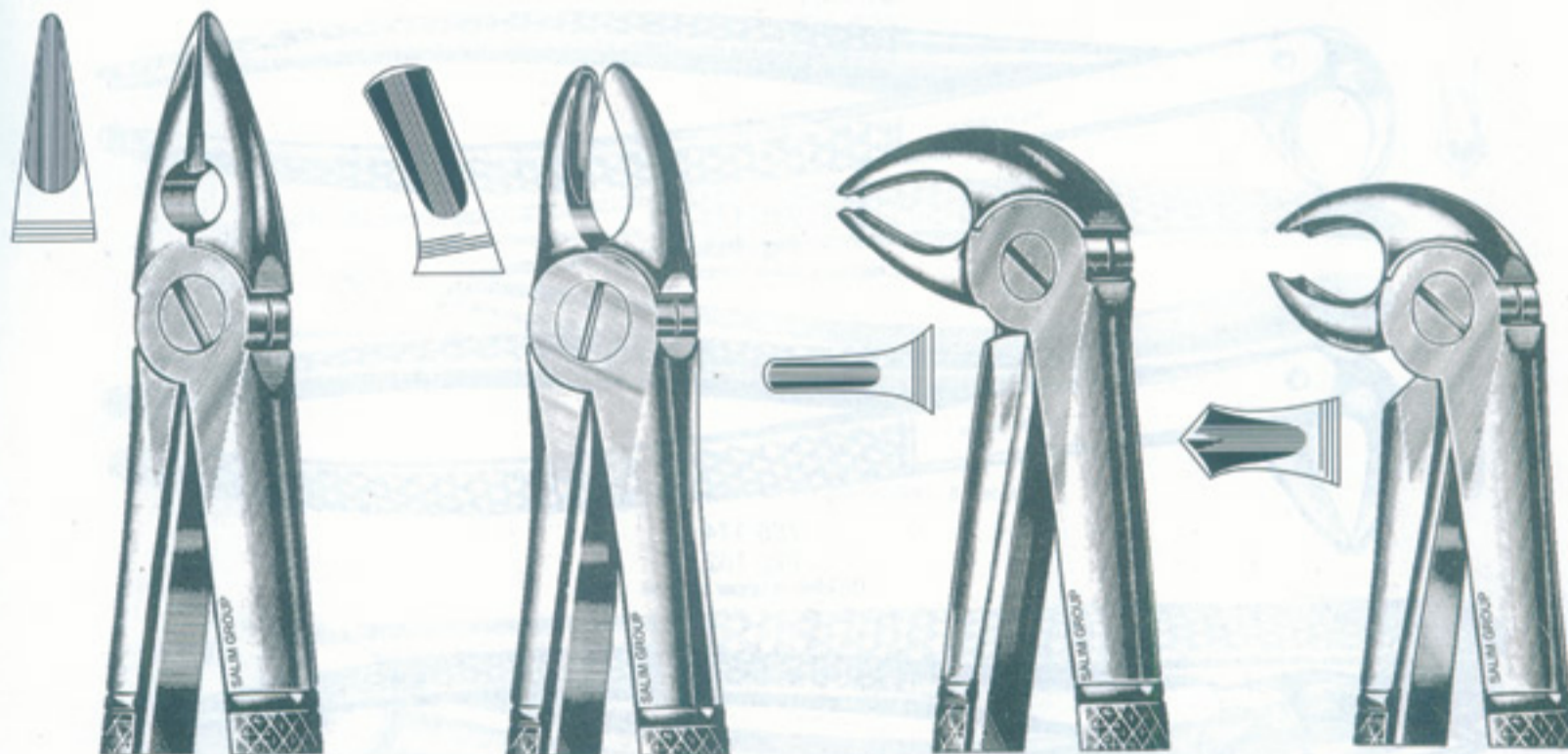

786-166
Fig. MD 1
Universal forceps for upper
wisdoms, premolars & roots

786-167
Fig. MD 2
Upper molars

786-168
Fig. MD 3
lower incisors, premolars
& roots

786-169
Fig. MD 4
Lowers molars



SALIM
Group Of Industries

EXTRACTING FORCEPS CHILDREN'S PATTERN



786-170
Fig. 158

Children's upper molars universal



786-171
Fig. 159

Children's upper teeth universal

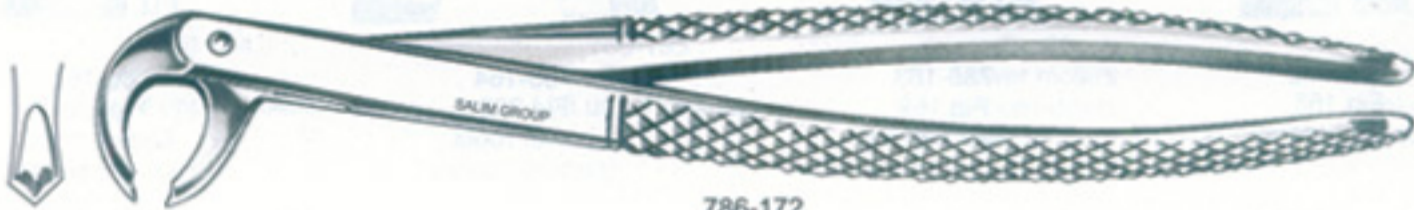

786-172
Fig. 160

Children's lower molars universal(hawk's bill)



786-173
Fig. 161

Children's lower centrals & roots



786-174
Fig. 162

Children's upper centrals



786-175
Fig. 163

Children's upper centrals

EXTRACTING FORCEPS
ENGLISH PATTERN



786-176
Fig. 37
Children's upper incisors & canines

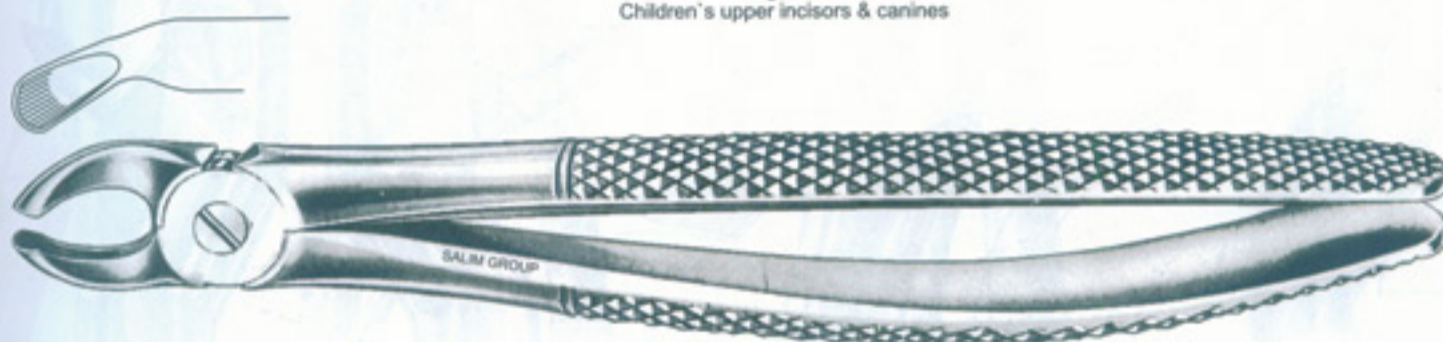

786-177
Fig. 39
Children's upper molars universal

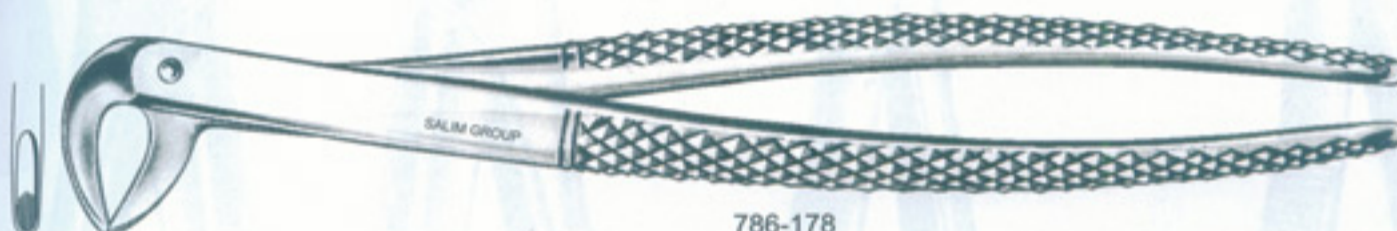

786-178
Fig. 123
Children's lower teeth universal

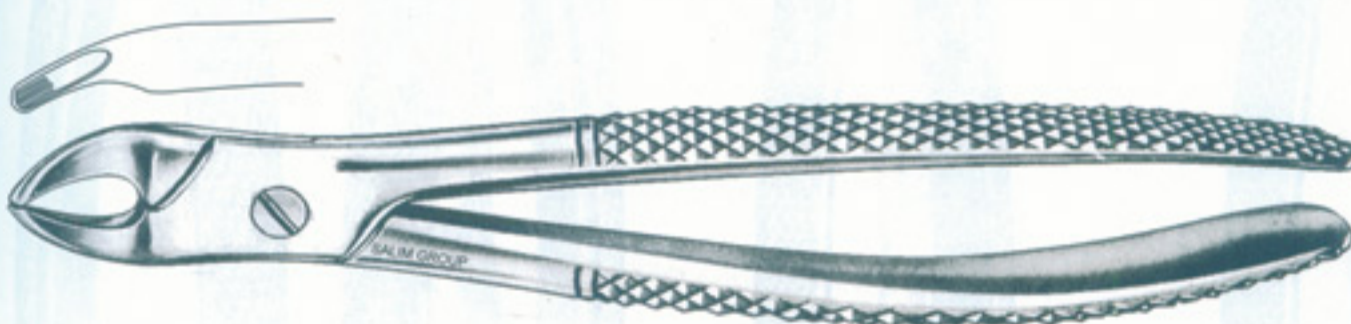

786-179
Fig. 138
Children's upper universal & roots

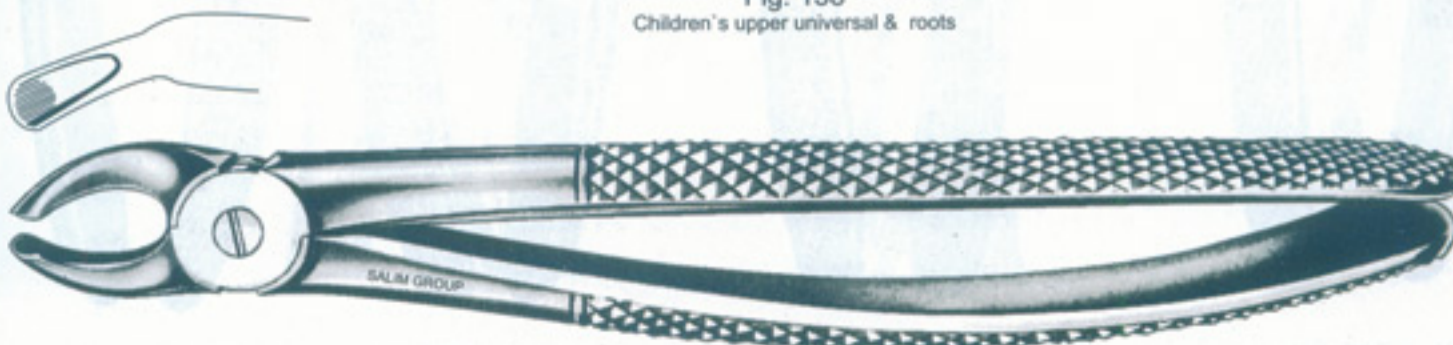

786-180
Fig. 157
Children's upper molars universal



SALIM
Group Of Industries

WISDOM TEETH EXTRACTING FORCEPS ROOT FRAGMENT FORCEPS



786-181
universal pattern for upper teeth



786-182
universal pattern for lower teeth



786-183
Fig. 22 1/2L
Left lower wisdoms
& molars

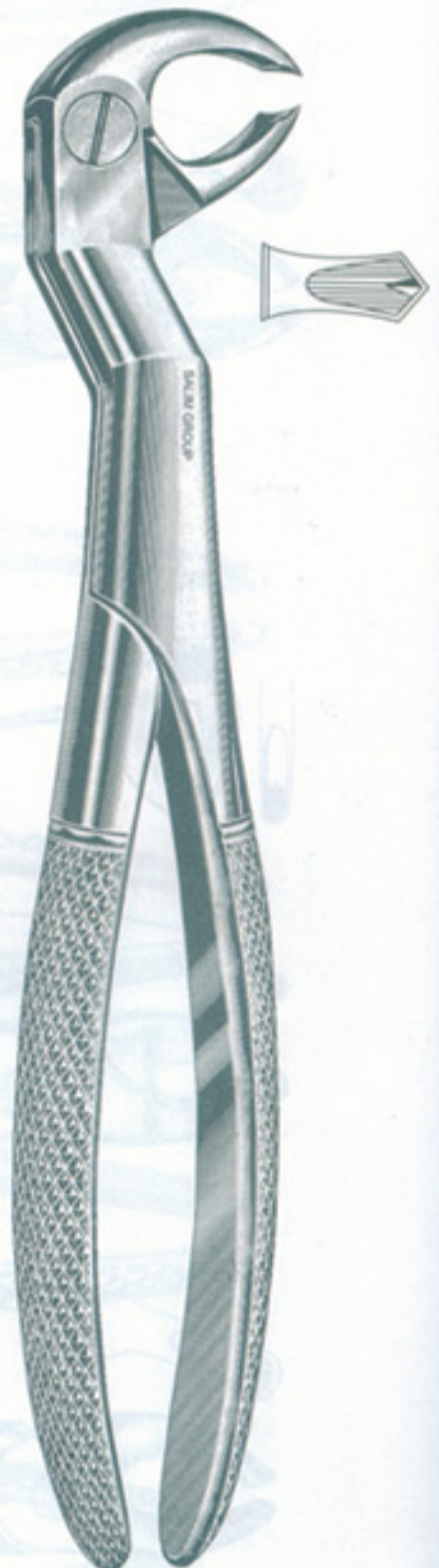

786-184
Fig. 22 1/2 R
Right lower wisdoms
& molars

TOOTH EXTRACTING FORCEPS FOR CHILDREN'S WITH SPRING



786-185
Fig. 3
Upper molars

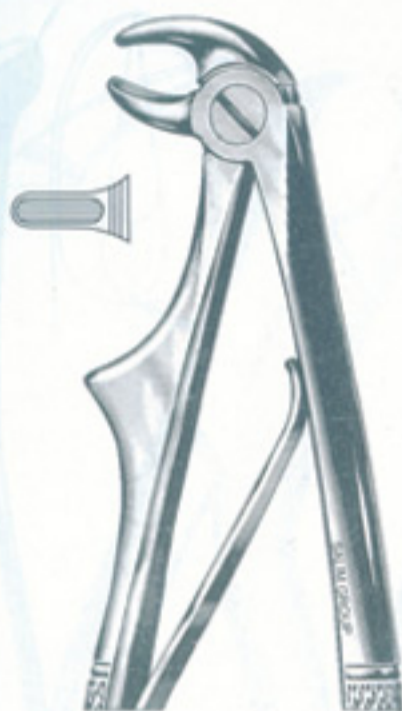

786-186
Fig. 5
Lower incisors

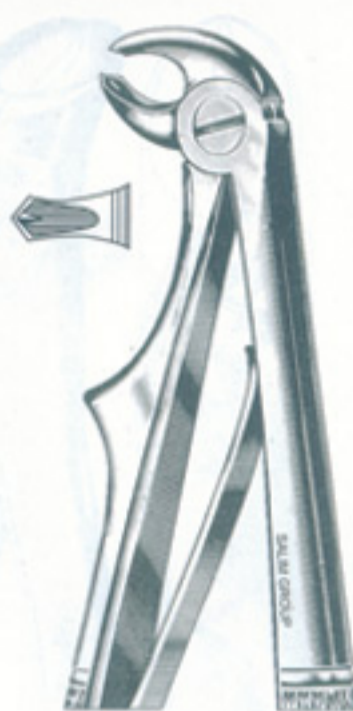

786-187
Fig. 6
Lower molars

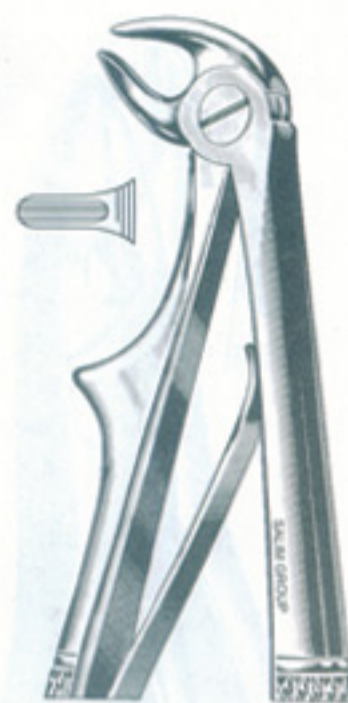

786-188
Fig. 7
Lower roots



786-189
Fig. 137
Upper incisors
& canines



786-190
Fig. 139
Upper premolars



786-191
Fig. 51S
Upper roots



SALIM
Group Of Industries

TOOTH EXTRACTING FORCEPS AMERICAN PATTERN

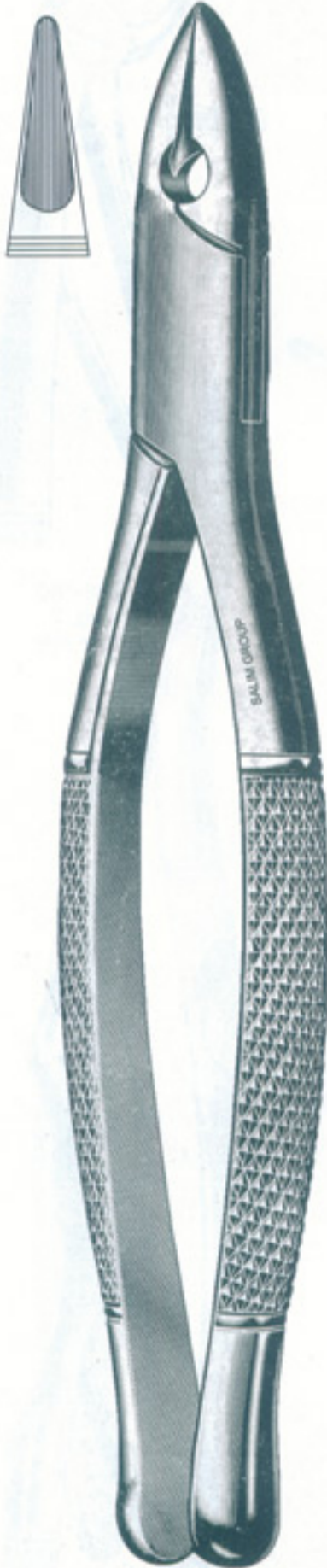

786-192
Fig. 1
Upper centrals, laterals & cuspids



786-193
Fig. 5
Lower third molars

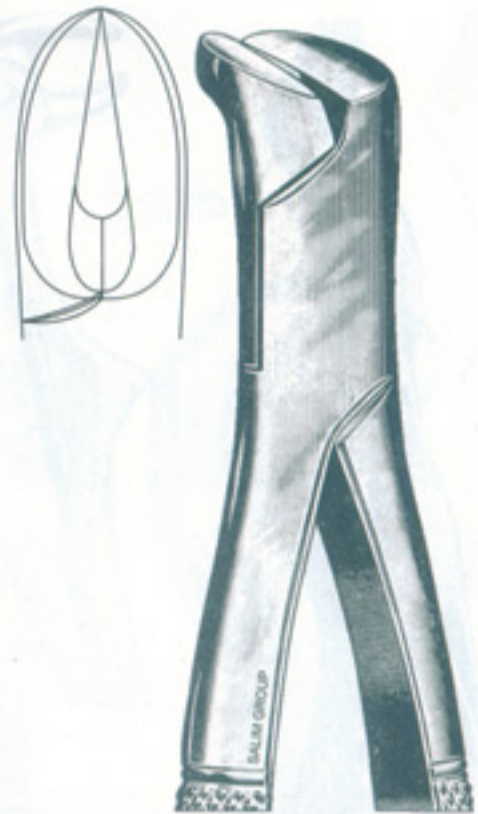

786-194
Fig. 6
Splitting forceps

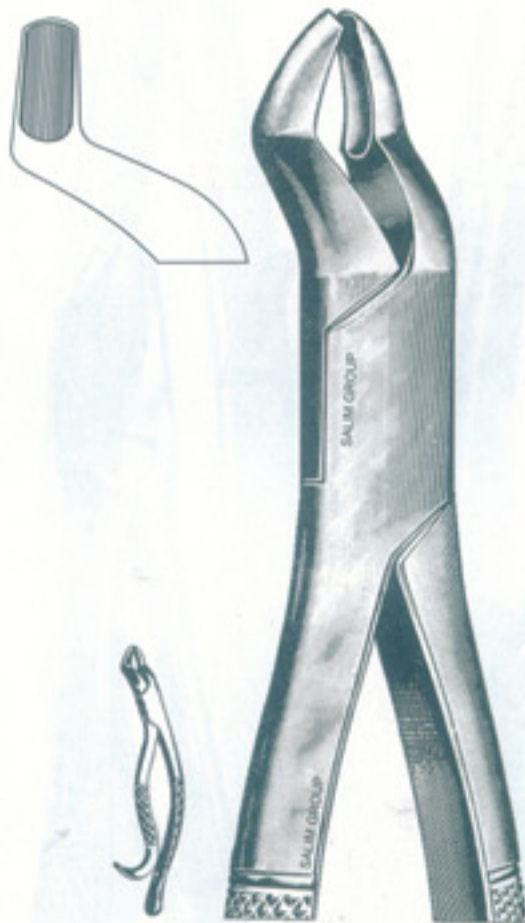

786-195
Fig. 10 H
upper molars
hook - handle

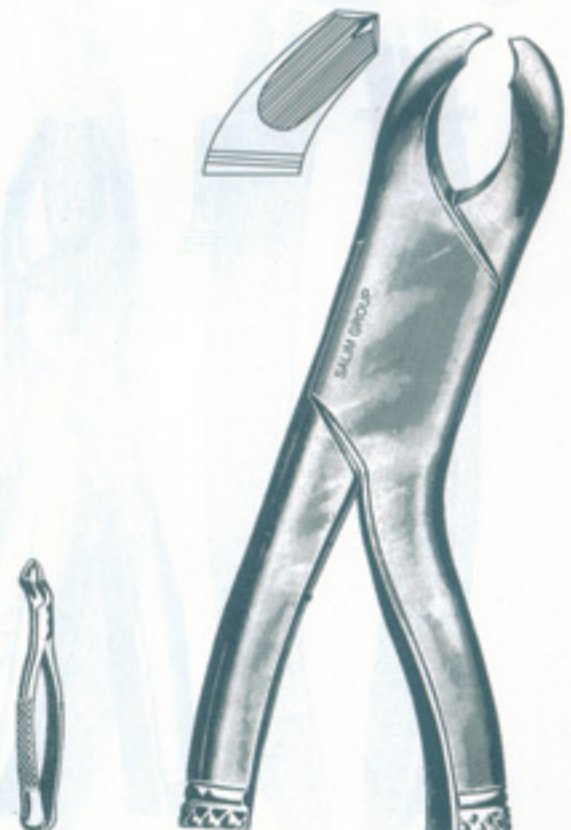

786-196
Fig. 10 S
upper molars
straight - handle



786-197
Fig. 15
Lower molars

TOOTH EXTRACTING FORCEPS AMERICAN PATTERN

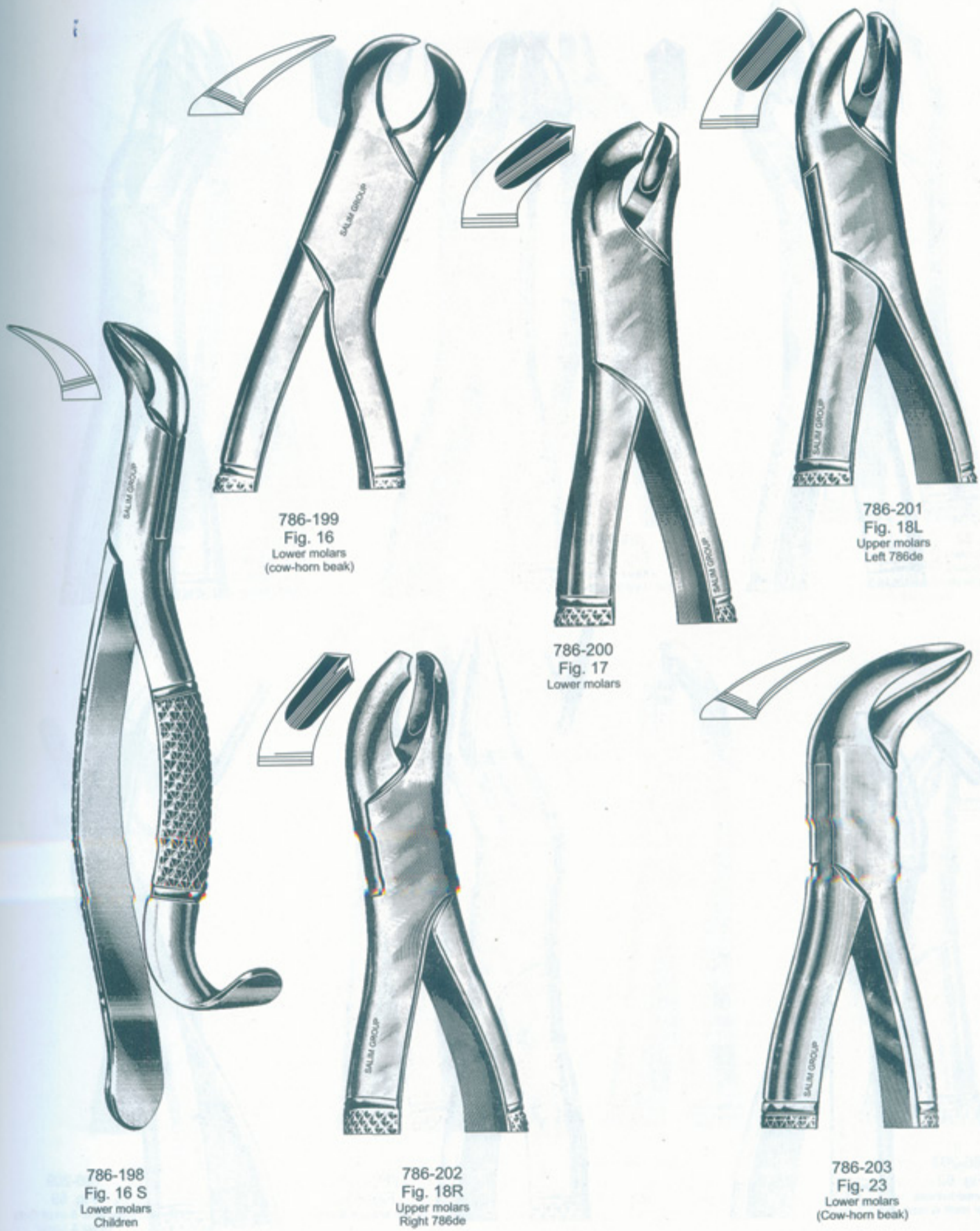

786-199
Fig. 16
Lower molars
(cow-horn beak)

786-200
Fig. 17
Lower molars

786-201
Fig. 18L
Upper molars
Left 786de

786-198
Fig. 16 S
Lower molars
Children

786-202
Fig. 18R
Upper molars
Right 786de

786-203
Fig. 23
Lower molars
(Cow-horn beak)



SALIM
Group Of Industries

TOOTH EXTRACTING FORCEPS AMERICAN PATTERN

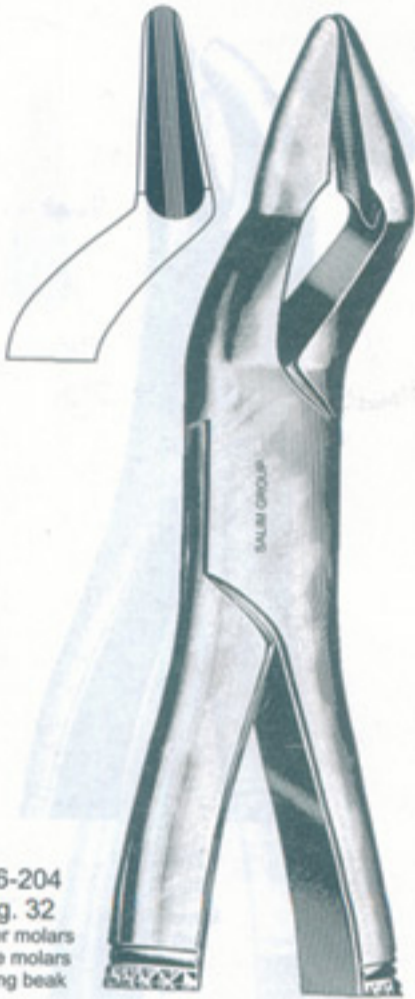

786-204
Fig. 32
Upper molars & pre molars
strong beak

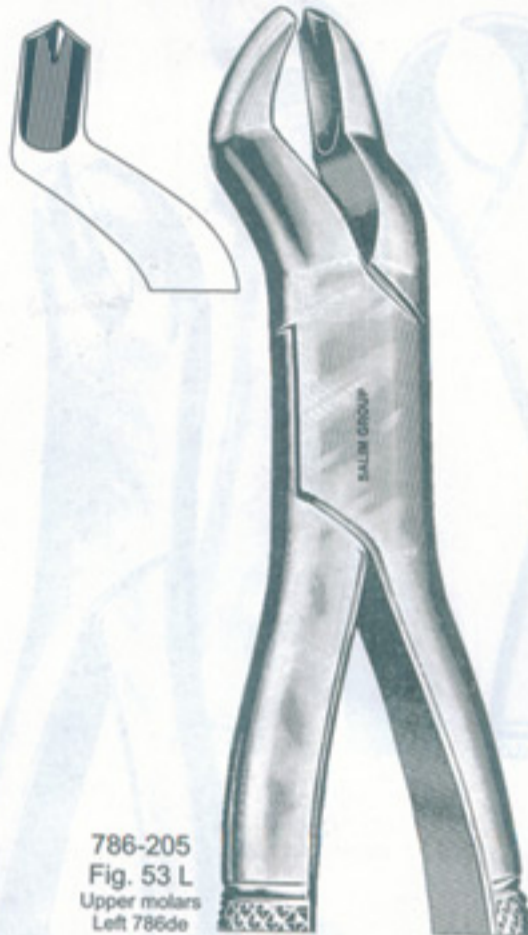

786-205
Fig. 53 L
Upper molars
Left 786de



786-206
Fig. 53 R
Upper molars
Right 786de

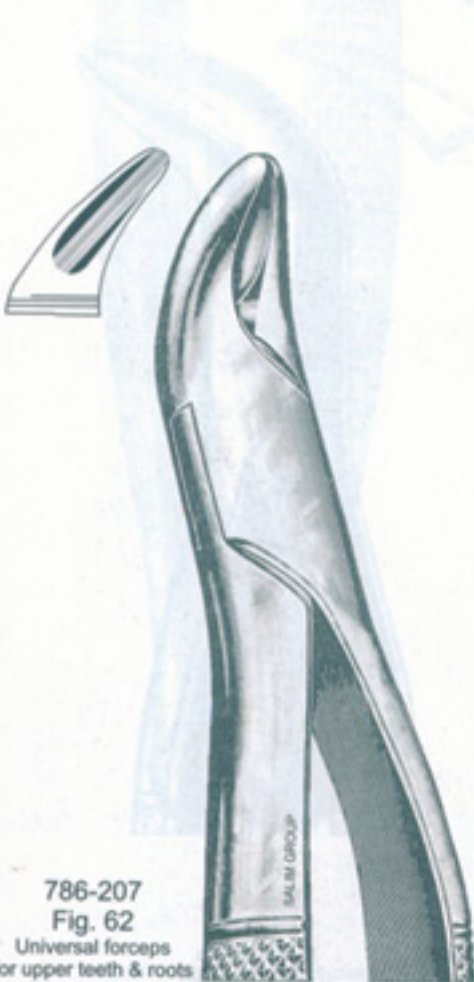

786-207
Fig. 62
Universal forceps
for upper teeth & roots

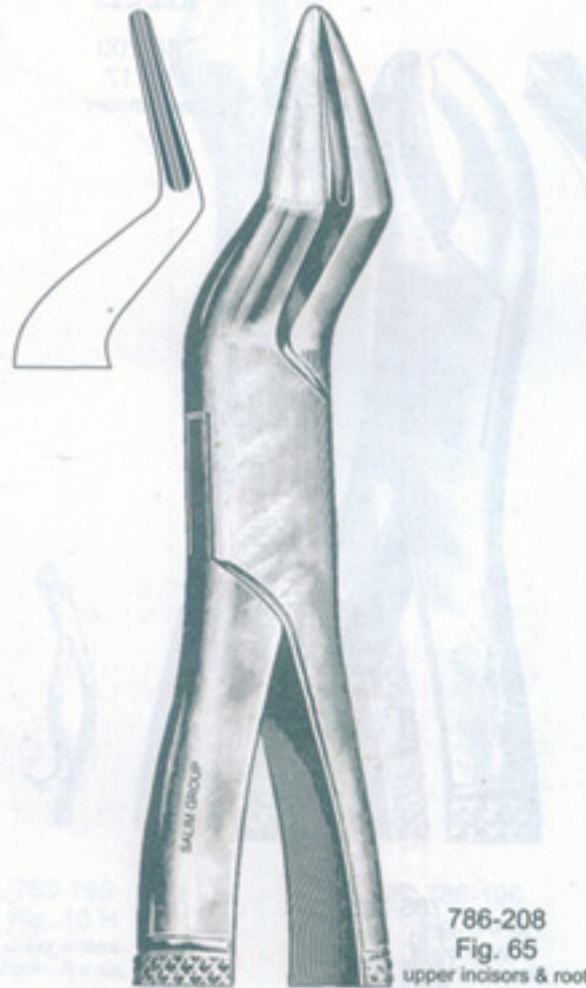

786-208
Fig. 65
upper incisors & root

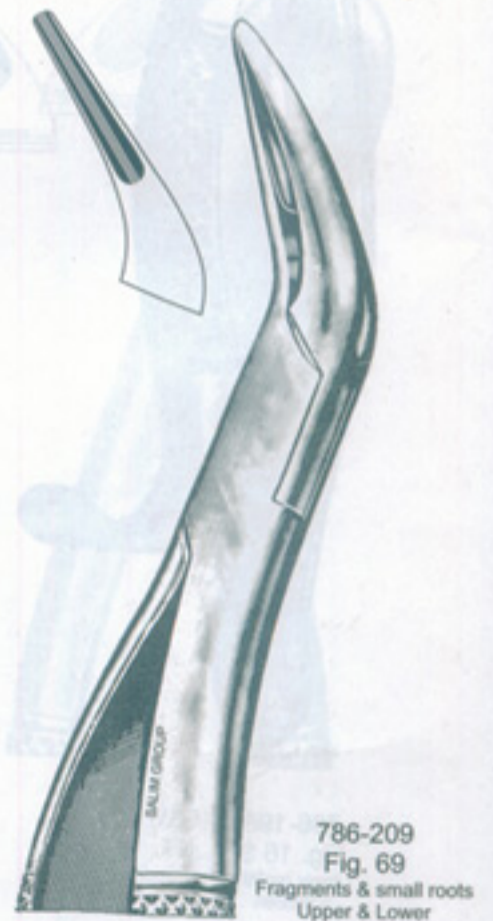

786-209
Fig. 69
Fragments & small roots
Upper & Lower

TOOTH EXTRACTING FORCEPS AMERICAN PATTERN



786-210
Fig. 88R
Right upper molars

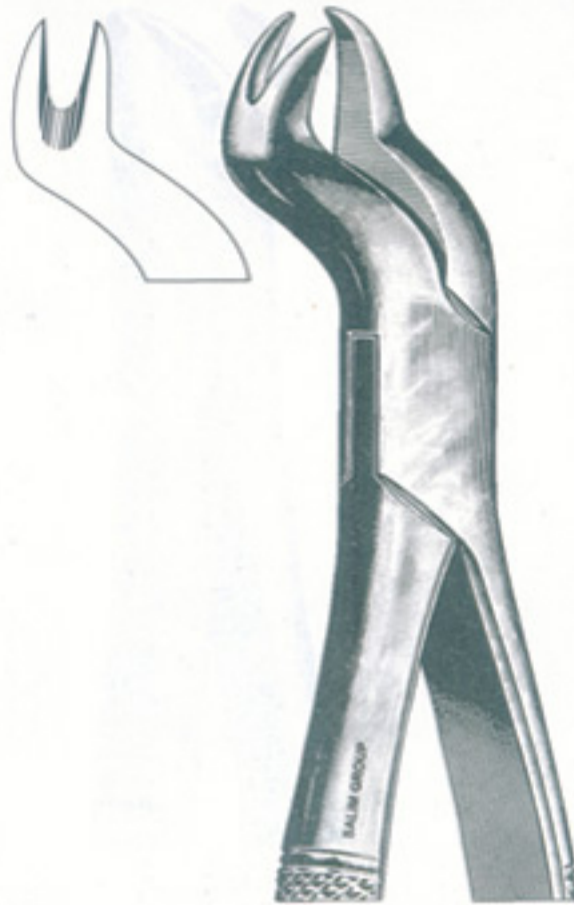

786-211
Fig. 88L
Left upper molars

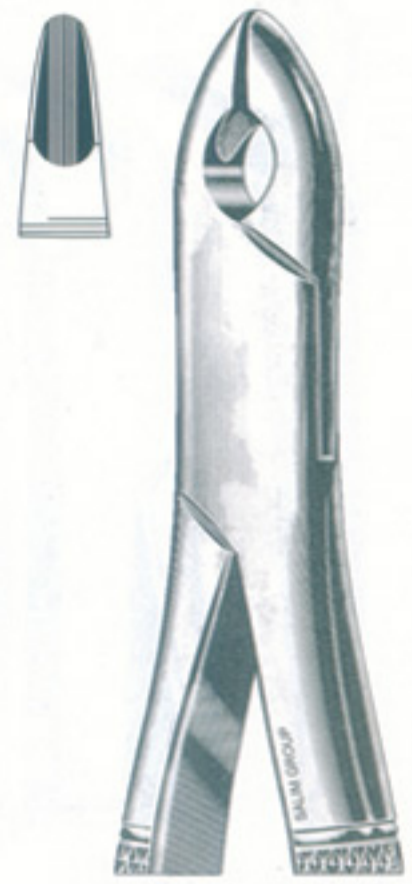

786-212
Fig. 99C
upper premolars,
molar & incisors



786-213
Fig. 101
Universal forceps
for premolars.

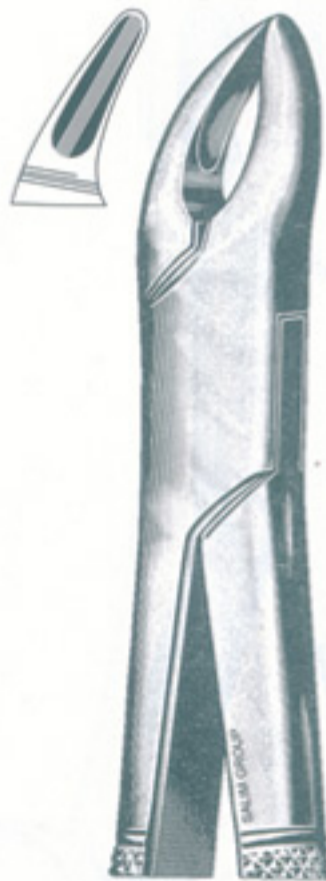

786-214
Fig. 150
Upper premolars,
incisors & roots

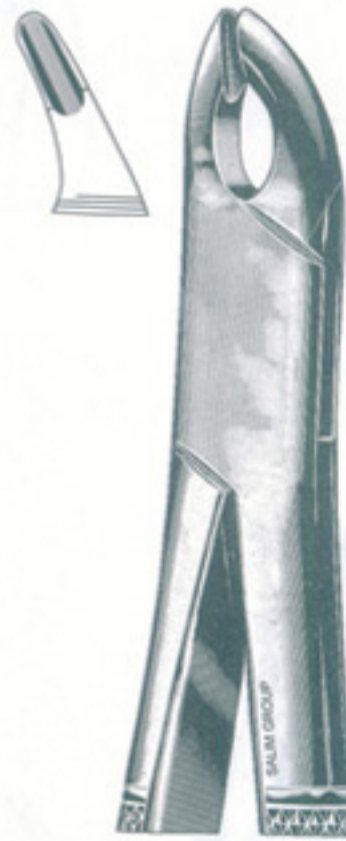

786-215
Fig. 150A
Upper premolars,
incisors & roots

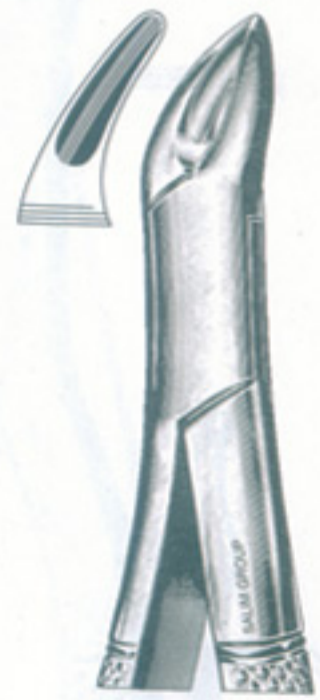

786-216
Fig. 150S
Upper premolars,
incisors & roots
for children



SALIM
Group Of Industries

TOOTH EXTRACTING FORCEPS AMERICAN PATTERN

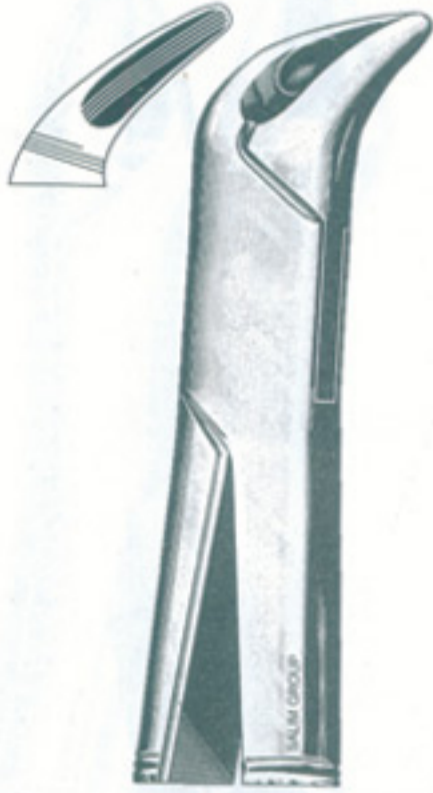

786-217
Fig. 151
Lower premolars, incisors & roots

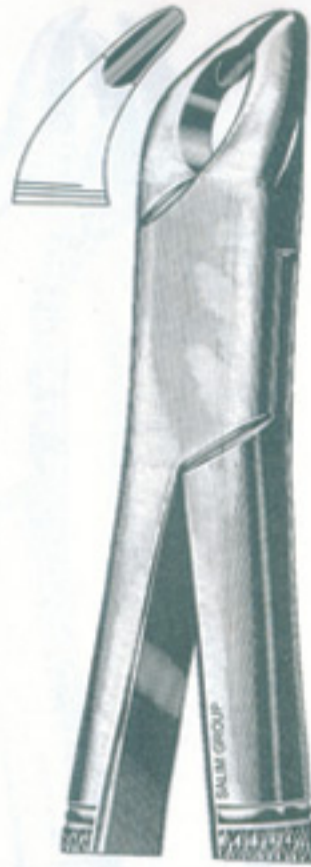

786-218
Fig.151A
Lower premolars, incisors & roots

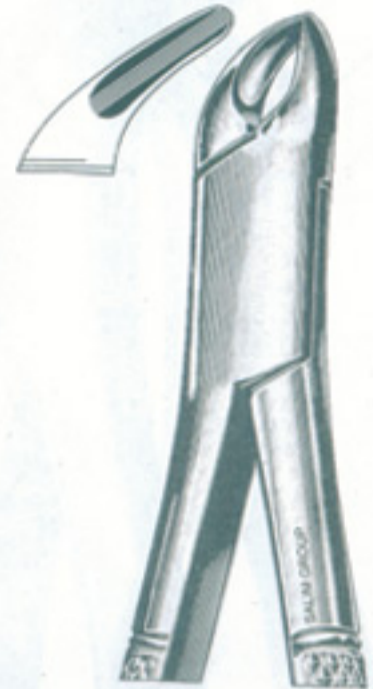

786-219
Fig.151S
Lower premolars, incisors & roots
for children

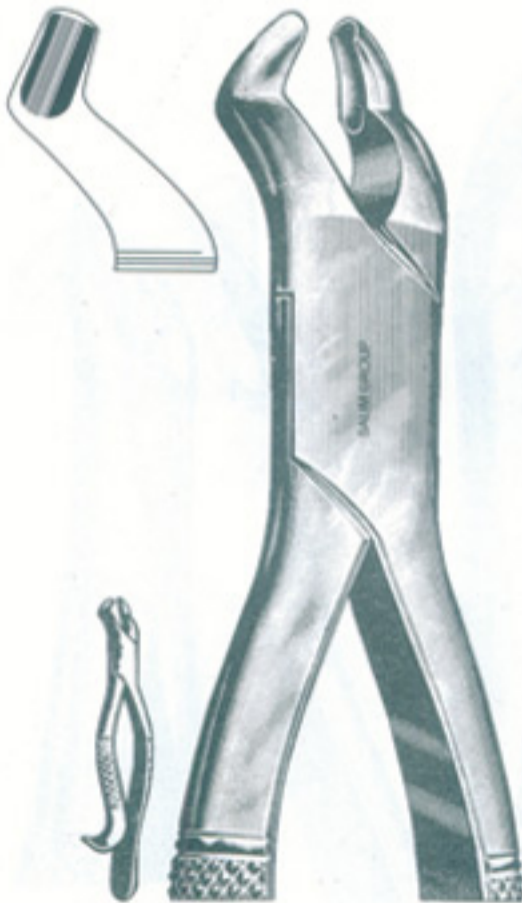

786-220
Fig.210H
Upper wisdoms
with hook handle

786-221
Fig.210S
Upper wisdoms
with straight handle

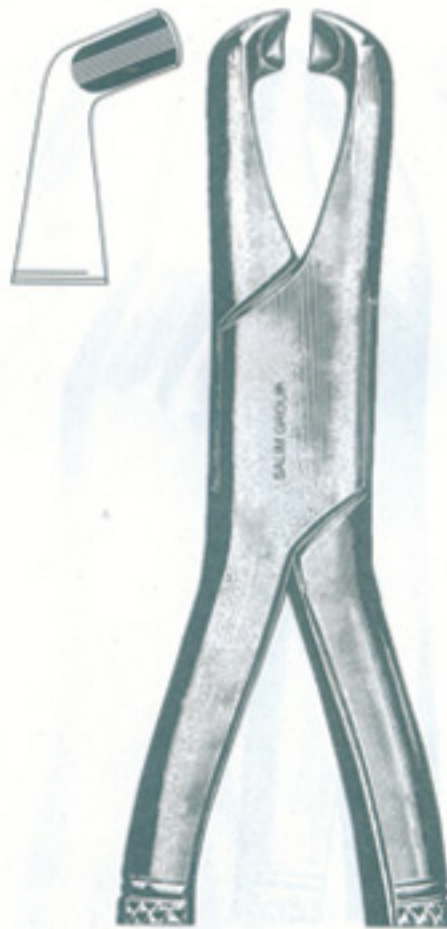

786-222
Fig.222
Lower wisdoms



786-223
Fig.286
Upper roots, premolars & incisors

ROOT SPLINTER FORCEPS EXTRACTION TWEEZER



786-224
Fig.1
Lower roots



786-225
Fig.2
Upper roots



786-226
Albrecht
16 cm



786-227
Albrecht
16 cm

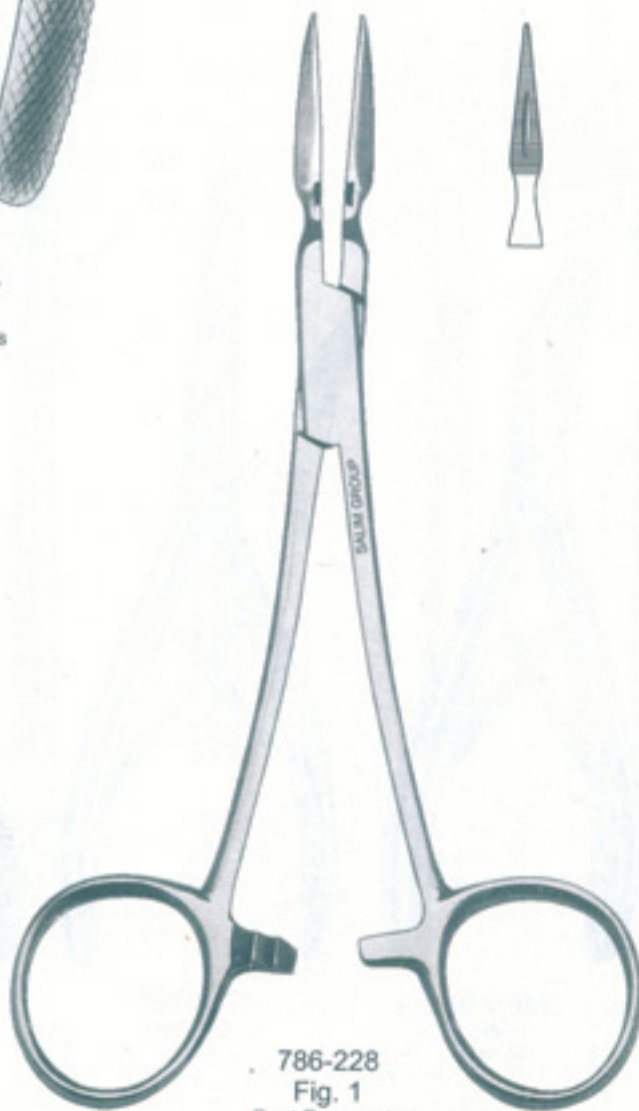

786-228
Fig. 1
Root Fragments

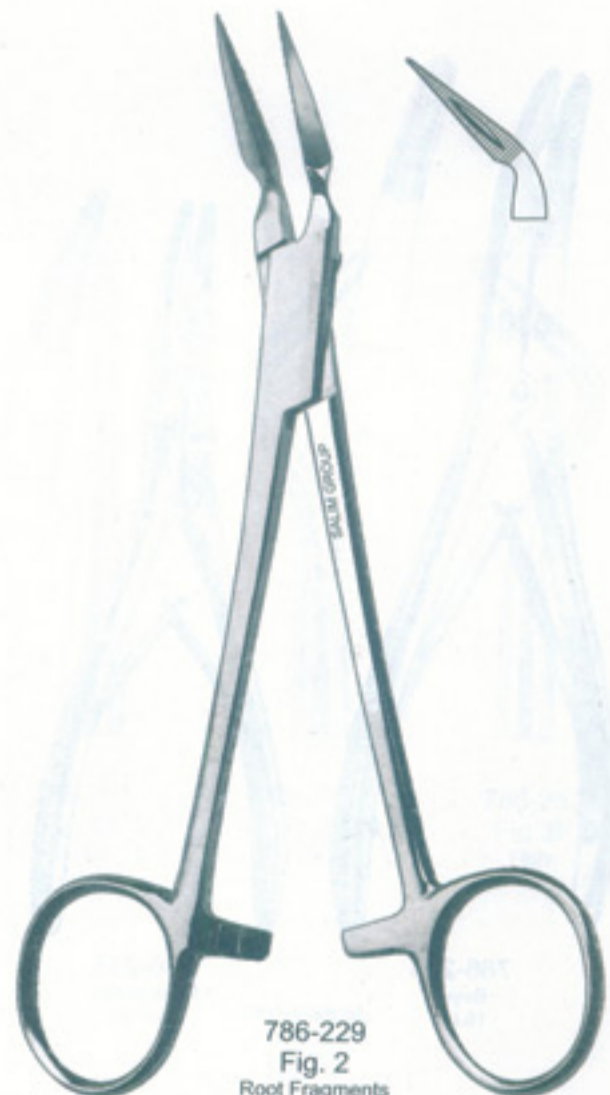

786-229
Fig. 2
Root Fragments



SALIM
Group Of Industries

BONE RONGEURS



786-230
Blumenthal
15 cm

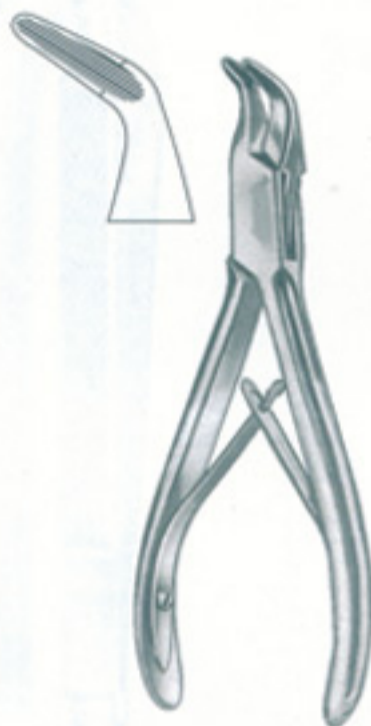

786-231
Blumenthal 45°
14,5 cm

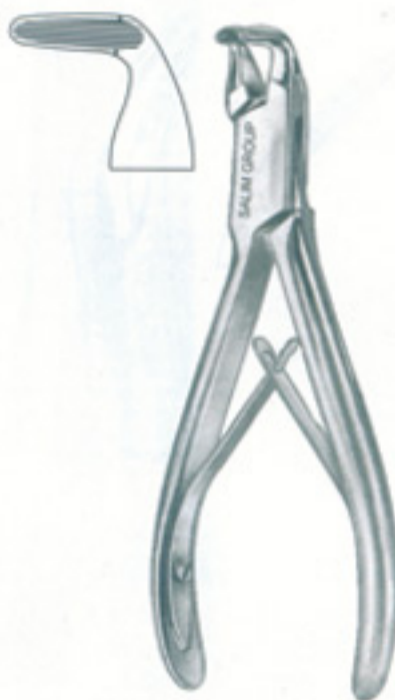

786-232
Blumenthal 90°
14 cm

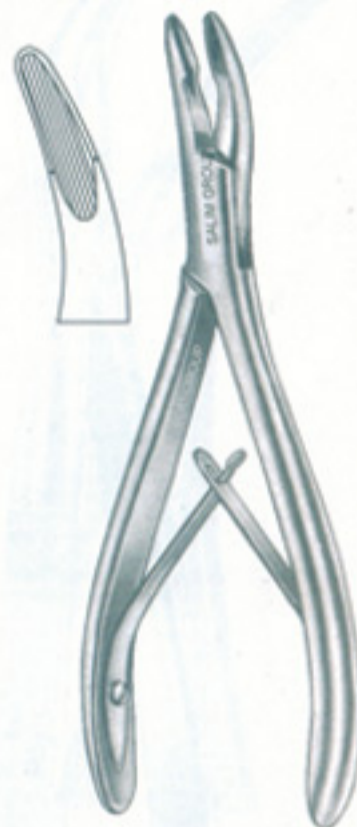

786-233
Mead 1A
16,5 cm



786-234
Beyer
18 cm
Multiple Action



786-235
Ruskin-mini
15,5 cm



786-236
Luer
15 cm



786-237
Friedman
14 cm



786-238
Mini-Friedman
12 cm

ROOT ELEVATORS



786-239
Fig.1B
Bein



786-240
Fig.2B
Bein



786-241
Fig.3B
Bein



786-242
Fig.4B
Bein



786-243
Fig.5B
Bein



786-244
Fig.6B
Bein



786-245
Fig.4SA
Schmeckebier-Apexo



786-246
Fig.5SA
Schmeckebier-Apexo



786-247
Fig.34S
Seldin



786-248
Fig.34
Seldin



786-249
Fig.2S
Seldin



786-250
Fig.3S
Seldin



786-251
Fig.1F
Flohr



786-252
Fig.2F
Flohr



786-253
Fig.3F
Flohr



SALIM
Group Of Industries

ROOT ELEVATORS

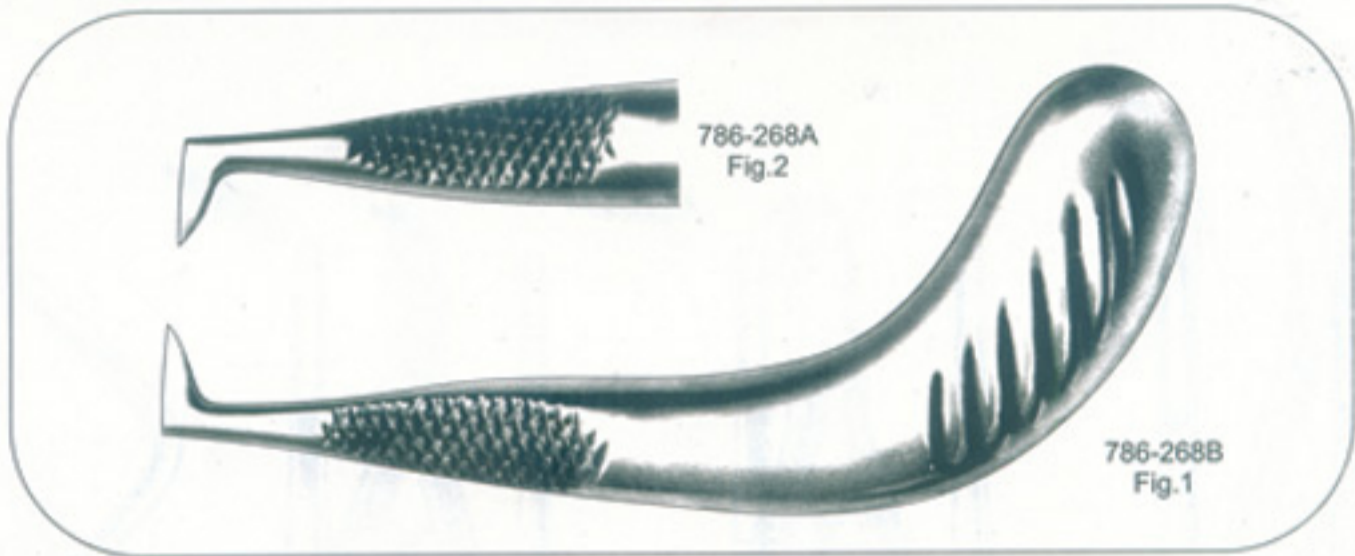

786-255
Fig.72
Miller-Apexo

786-256
Fig.73
Miller-Apexo

786-257
Fig.74
Miller-Apexo

786-258
Fig.19

786-259
Fig.20

786-260
Fig.51
Curtis

786-261
Fig.52
Curtis

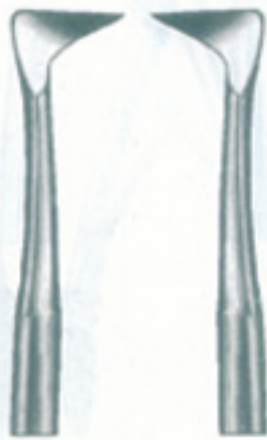

786-254
Fig.71
Miller-Apexo

786-262
Fig.1L
Seldin



786-263
Fig.1R
Seldin



786-264
Fig.4L
Seldin



786-265
Fig.4R
Seldin



786-266
Fig.11
Stout



786-267
Fig.11A
Stout



786-268
Fig.44C
Stout

ROOT ELEVATORS

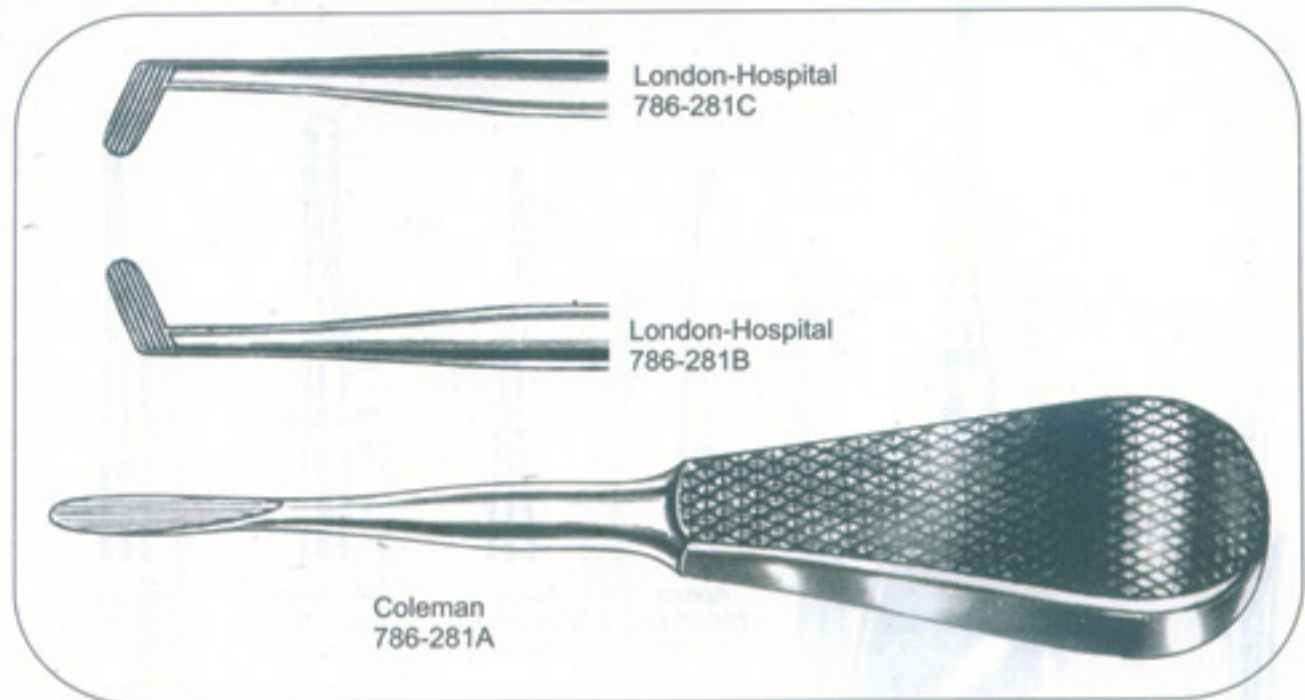

786-269
Fig.A
Cogswell



786-270
Fig.B
Cogswell



786-271
Fig.301
Apexo



786-272
Fig.302
Apexo



786-273
Fig.303
Apexo



786-274
Fig.301W
Seldin



786-275
Fig.304W
Seldin



786-276
Fig.1H
Heidbrink



786-277
Fig.2H
Heidbrink



786-278
Fig.40H
Heidbrink



786-279
Fig.41H
Heidbrink



786-280
Fig.46



786-281
Fig.46R



SALIM
Group Of Industries

ROOT ELEVATORS



Apexo
DB225001
Stainless steel handle
Fig. 301



Apexo
786-296A
Fig. 302



Apexo
786-296B
Fig. 303



Heidbrink
786-296C
Fig. 1H



Heidbrink
786-296D
Fig. 2H



Heidbrink
786-296E
Fig. 40H



Heidbrink
786-296F
Fig. 41H



786-282
Fig.44
Cryer



786-283
Fig.45
Cryer



786-284
Fig.25
Cryer



786-285
Fig.26
Cryer



786-286
Fig.31
Cryer



786-287
Fig.32
Cryer



786-290
Fig.81A



786-291
Fig.81E



786-292
Fig.190



786-293
Fig.191



786-294
Fig.23



786-295
Fig.24



786-296
Fig.98

786-282
Fig.44
Cryer

ROOT ELEVATORS





SALIM
Group Of Industries

ROOT ELEVATORS



Hylin
786-324A
Stainless steel
handle
Fig. 1



Hylin
786-324B
Fig. 2



Hylin
786-324C
Fig. 3



Hylin
786-324D
Fig. 3



786-313
Fig.1
Bein



786-314
Fig.2
Bein



786-315
Fig.3
Bein



786-316
Fig.4
Bein



786-317
Fig.5
Bein



786-318
Fig.6
Bein



786-319
Fig.1



786-320
Fig.2



786-321
Fig.2
Flohr



786-322
Fig.3
Flohr



786-323
Fig.7
Cryer



786-324
Fig.8
Cryer

ROOT ELEVATORS



786-326
Walter F. Barry



786-327
Fig.320



786-328
Fig.321



786-329
Fig.322



786-330
Fig.323

Walter F. Barry



786-331
Fig.2
Heidbrink



786-332
Fig.3
Heidbrink



786-325
Fig.1
Heidbrink



786-333
Winter



786-334
Fig.11LW



786-335
Fig.11RW



786-336
Fig.12LW



786-337
Fig.12RW

Winter



786-338
Fig.1
Warwick- James



786-339
Fig.2
Warwick- James



786-340
Fig.3
Warwick- James



SALIM
Group Of Industries

PLIERS FOR ORTHODONTICS & PROSTHETICS



786-341
Waldsachs
15 cm



786-342
Universal
16 cm

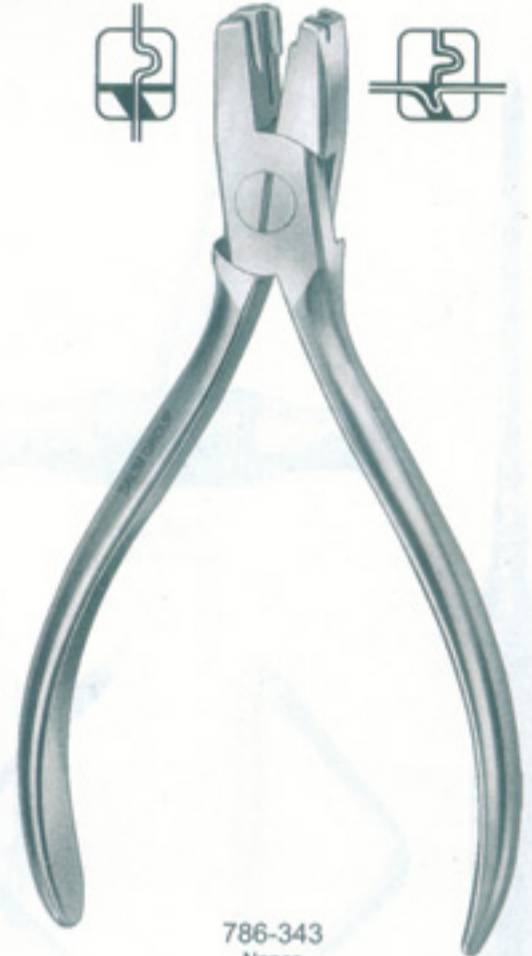

786-343
Nance
13.5 cm

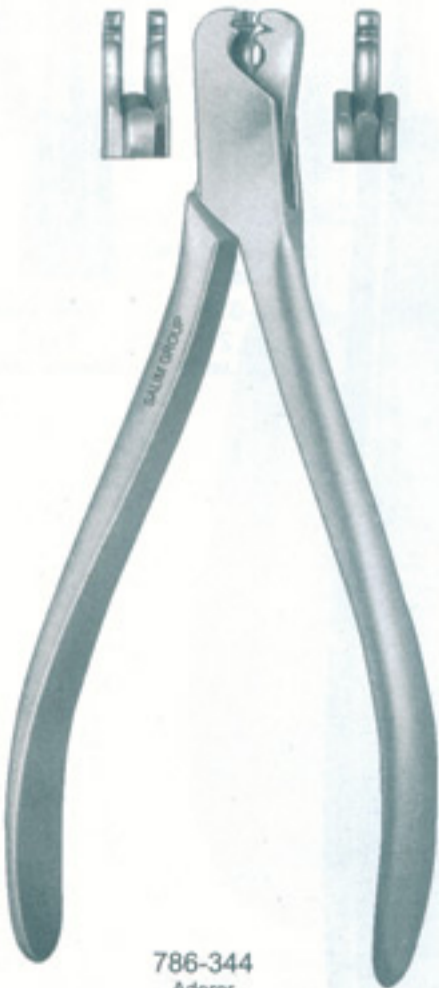

786-344
Aderer
14.5 cm



786-345
Modell marburg
Serrated Jaws
14 cm



786-346
Modell marburg
Smooth jaws
14 cm

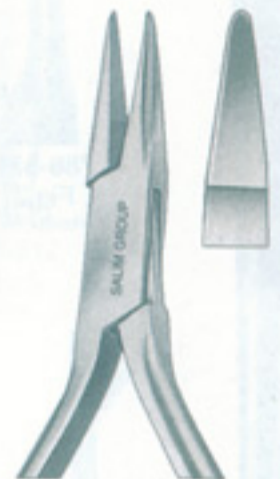

786-347
Modell marburg
Carbid Inserts jaws
14 cm



786-348
Goslee
One Serrated Jaws
14 cm

PLIERS FOR ORTHODONTICS & PROSTHETICS



786-349
14 cm



786-350
14 cm



786-351
14 cm



786-352
14,5 cm



786-353
14,5 cm



786-354
14 cm



786-355
14 cm



786-356
14 cm



786-357
Serrated Jaws
12 cm



786-358
How
14,5 cm



786-359
How-angled
14,5 cm



786-360
Arrow clasp forming
12 cm



786-361
Arrow clasp forming
12 cm



786-362
Arrow clasp bending
12 cm



SALIM
Group Of Industries

PLIERS FOR ORTHODONTICS & PROSTHETICS



786-363
Peeso
13,5 cm

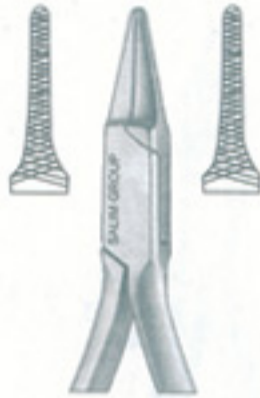

786-364
Peeso
13,5 cm



786-365
14 cm

Round nose pliers



786-366
Langenbeck
14 cm

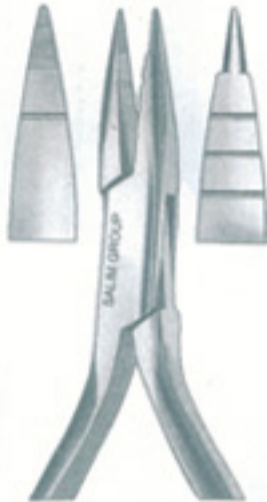

786-367
14 cm



786-368
13 cm



786-369
Angle
12,5 cm

For wire up to



0,7 mm \varnothing

1,0 mm \varnothing



786-370
Andresen
13 cm

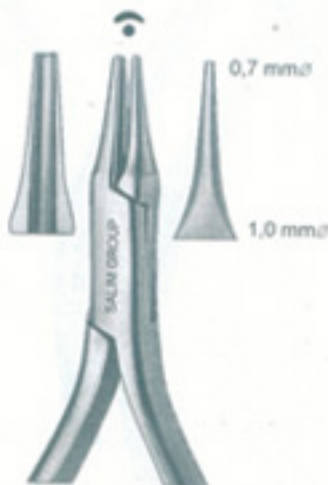

0,7 mm \varnothing

1,0 mm \varnothing

786-371
13,5 cm



0,5 mm \varnothing

0,7 mm \varnothing

786-372
Schwarz
13,5 cm

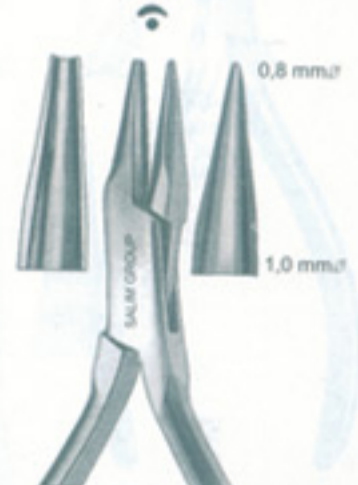

0,8 mm \varnothing

1,0 mm \varnothing

786-373
Fischer
13 cm

PLIERS FOR ORTHODONTICS & PROSTHETICS



786-374
Aderer
12 cm



786-375
Aderer- Heavy
12 cm

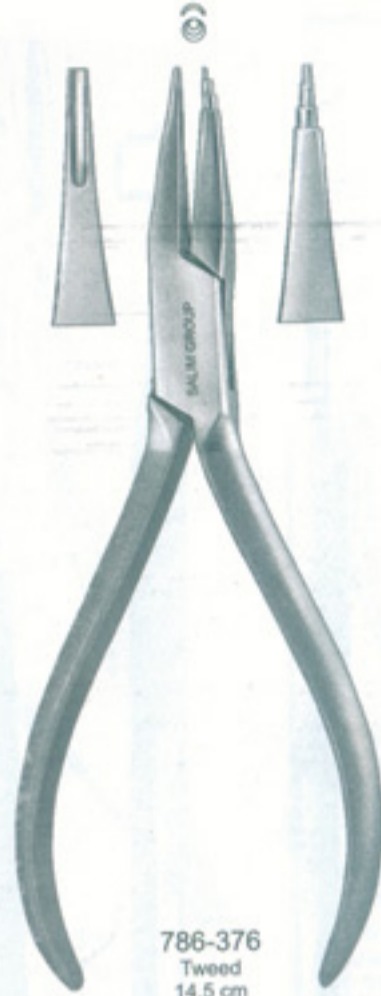

786-376
Tweed
14,5 cm



786-377
O'Brien
13,5 cm



786-378
Wire bending pliers
12,5 cm



786-379
Adams
12,5 cm

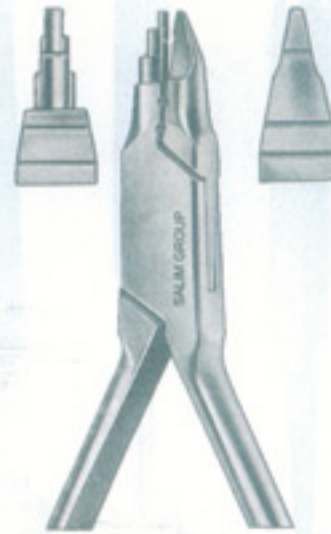

786-381
Young
14 cm



786-380
Frevert
12,5 cm



786-382
Clasp forming
14 cm



SALIM
Group Of Industries

ORTHODONTICS INSTRUMENTS

Ligature instruments



786-383
Band seating &
removing instruments

786-384

786-385

786-386
Elastic instruments



786-387
Mershon Band Pusher
14 cm



786-388
Band Setter with
tin insert
15 cm

Bracket holding tweezers



786-389
13,5 cm



786-390
14 cm

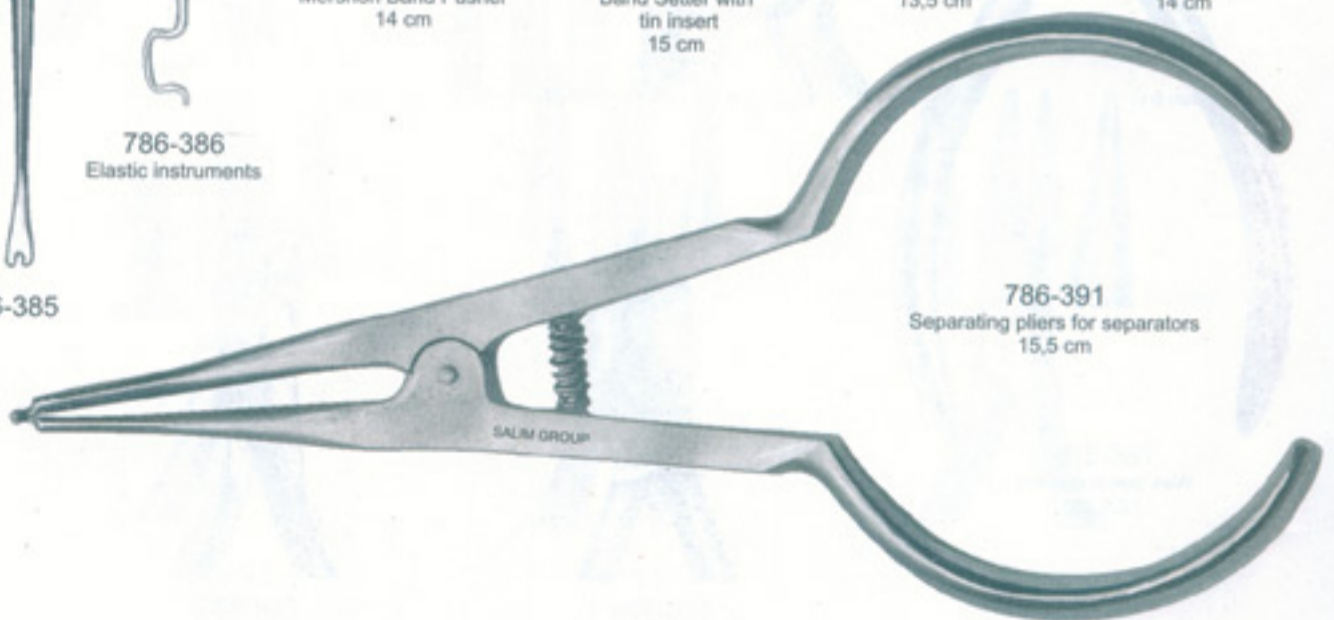

786-391
Separating pliers for separators
15,5 cm

ORTHODONTICS INSTRUMENTS



786-392
Mathieu pliers
14 cm



786-393
Elastic ligature placing pliers
14 cm



786-394
Mathieu ligating pliers
14 cm



786-395
Mathieu plier
with finger ring
14 cm



786-396
Mosquito plier



786-398
Bracket placing tweezer



786-399
Bracket placing tweezer



786-397
Bracket positioning gauge



786-400
Ligature tying plier



786-401
Bracket holding tweezer



786-402
Band seating instrument
Nylon



786-403
Mosquito forceps



Hook





SALIM
Group Of Industries

GUM SCISSORS

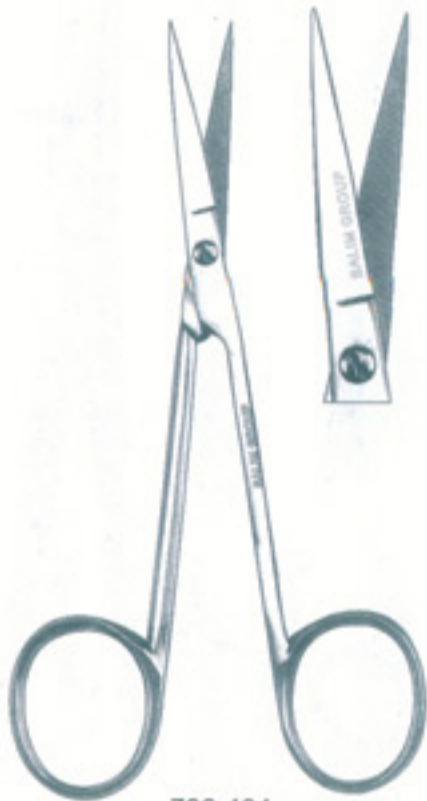

786-404
Fig.1
12cm
Straight



786-405
Fig.2
12cm
Curved

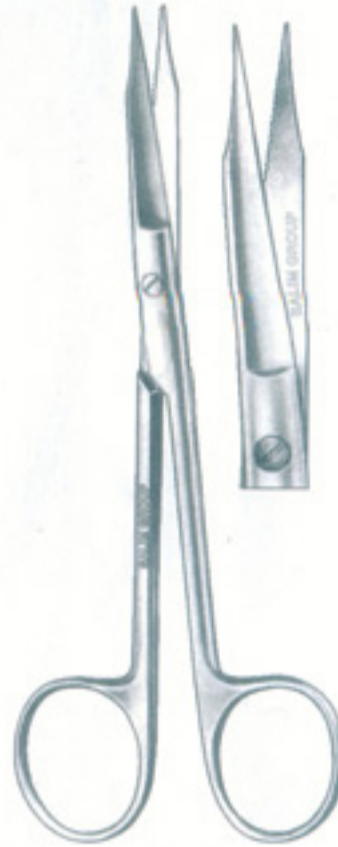

786-406
Fig.1
13cm
Goldman-Fox
Saw edge
Straight



786-407
Fig.2
13cm
Goldman-Fox
Saw edge
Curved

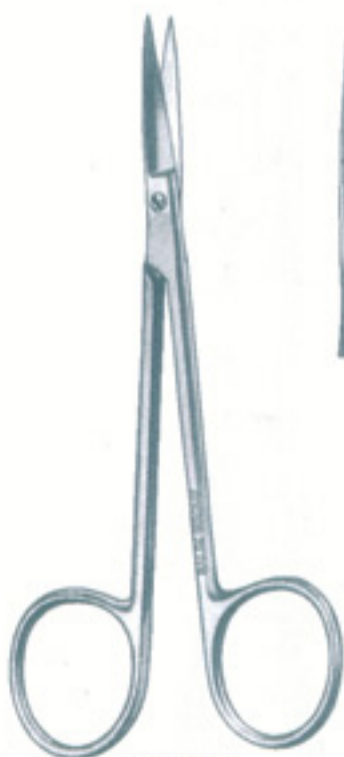

786-408
Fig.1
11,5cm
Iris
Straight



786-409
Fig.2
11,5cm
Iris
Curved



786-410
Fig.3
11,5cm
Iris



786-412
Fig.2
11,5cm
Angular



786-411
Fig.1
11,5cm
Angular, Saw edge

GUM SCISSORS

Curved, saw edge



786-413
Fig.1
La Grange
10,5 cm



Straight

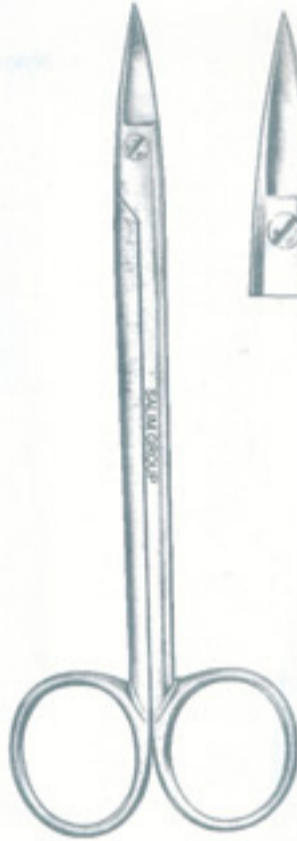

786-414
Fig.1
Quinby
12,5 cm



Curved



786-415
Fig.2
Quinby
12,5 cm

Curved, saw edge



786-416
Fig.3
Goldman-Fox (Special)
13 cm

Straight

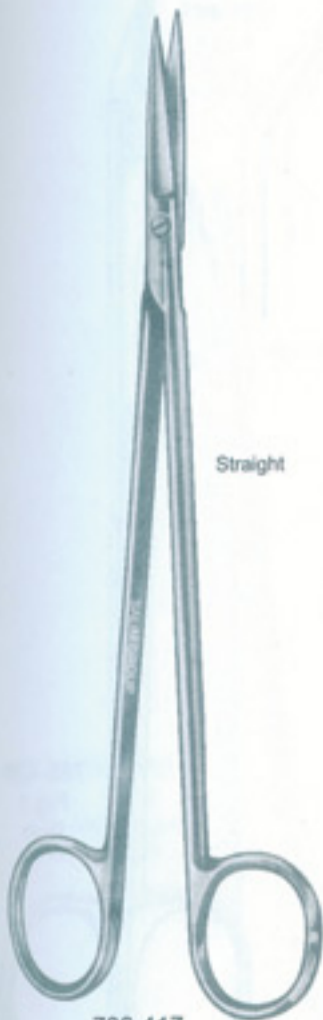

786-417
Fig.1
Kelly
16 cm



Curved

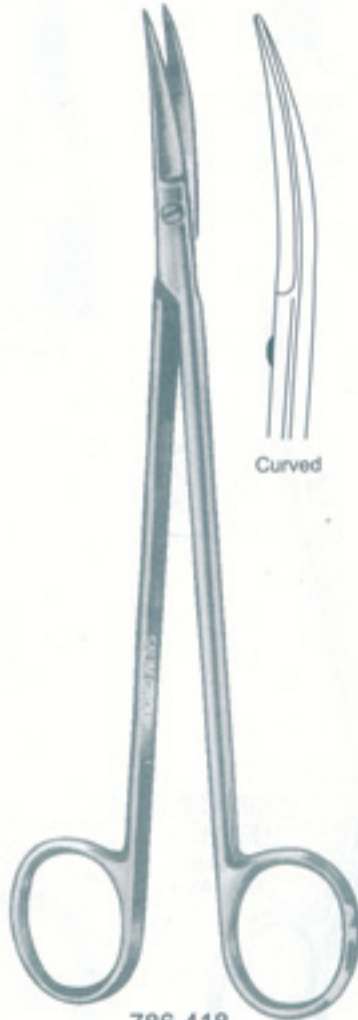

786-418
Fig.2
Kelly
16 cm

saw edge

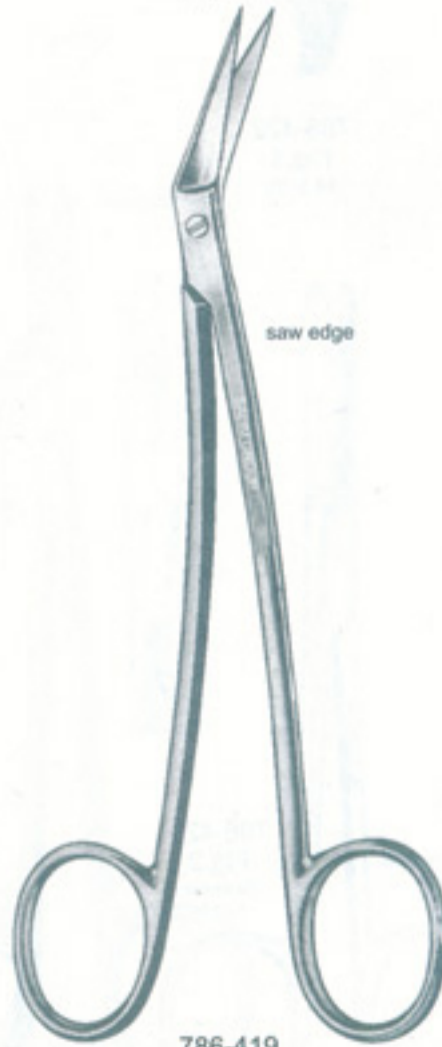

786-419
Fig.1
Locklin
16,5 cm

saw edge



786-420
Fig.2
Locklin
16,5 cm



SALIM
Group Of Industries

SURGICAL SCISSORS

Very fine points

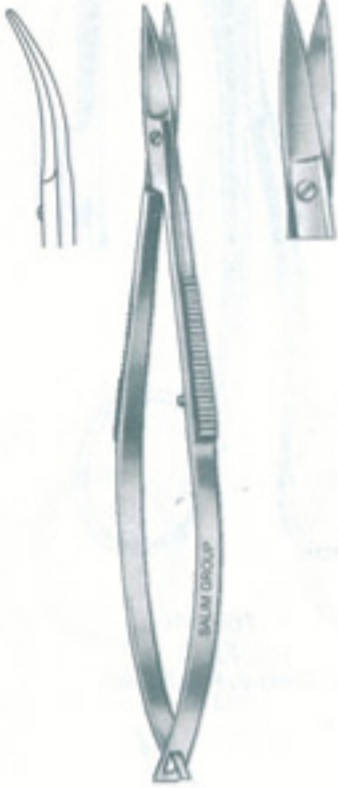

786-421
Fig.1
Noyes (Castroviejo)
12 cm

Very fine points



786-422
Fig.1
14,5 cm

Blunt points



786-423
Fig.1
Westcoot
11 cm

Sharp points



786-424
Fig.2
Westcoot
11 cm



Curved saw edge

786-425
Fig.1
Spencer
9 cm

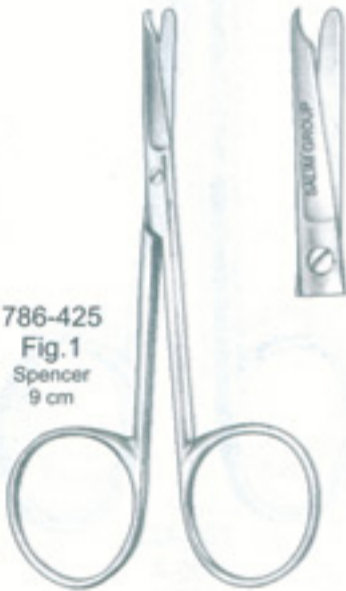

786-426
Fig.2
Spencer
13 cm



786-427
Fig.1
Neumann
12,5 cm

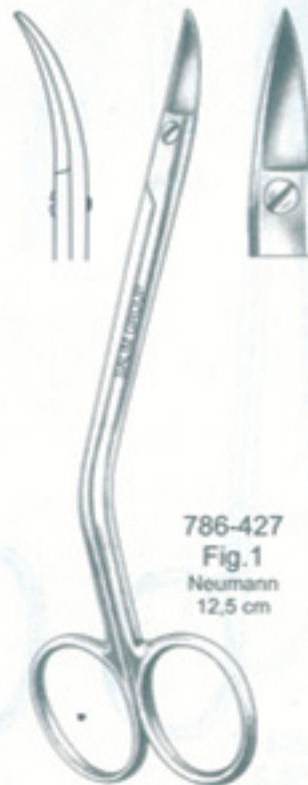

786-428
Fig.1
Dean
17 cm



GUM SCISSORS



786-429
Fig.1
Mayo
14,5 cm

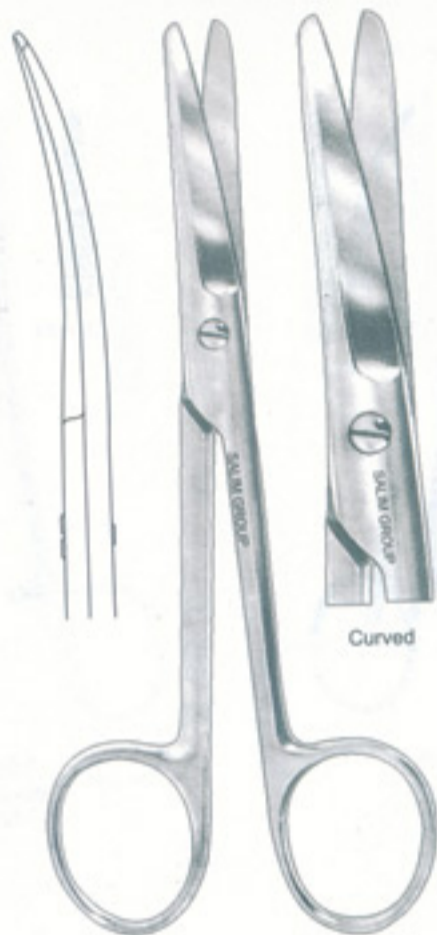

786-430
Fig.2
Mayo
14,5 cm

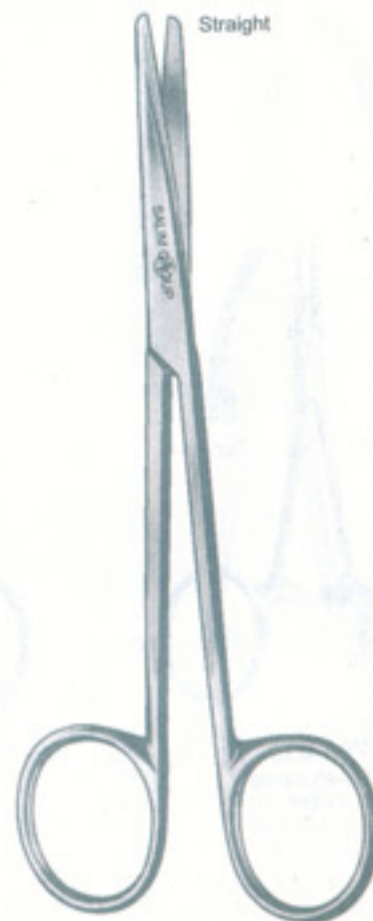

786-431
Fig.1
Metzenbaum
14,5 cm

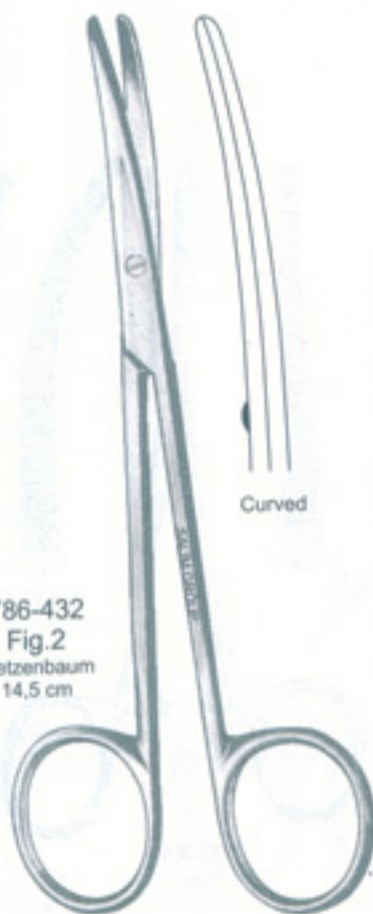

786-432
Fig.2
Metzenbaum
14,5 cm



786-433
Fig.1
Metzenbaum-Delicate
14,5 cm

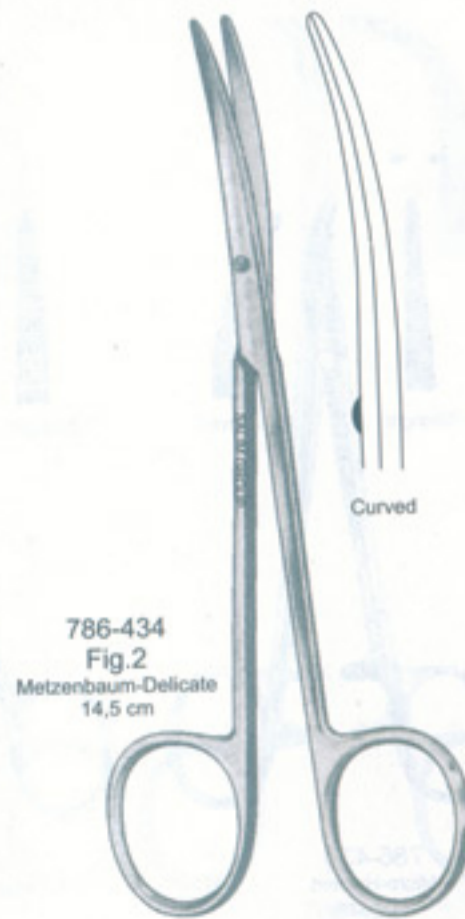

786-434
Fig.2
Metzenbaum-Delicate
14,5 cm



SALIM
Group Of Industries

HAEMOSTATIC FORCEPS

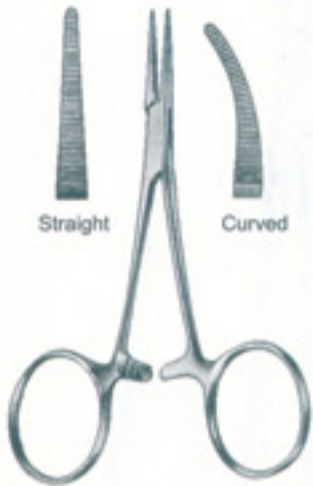

786-435
Baby-Mosquito
10 cm

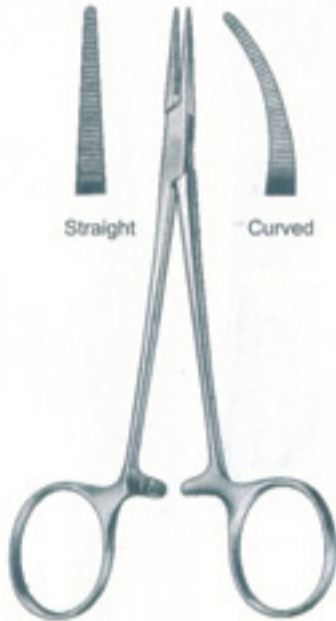

786-436
Micro-Halsted
12,5 cm

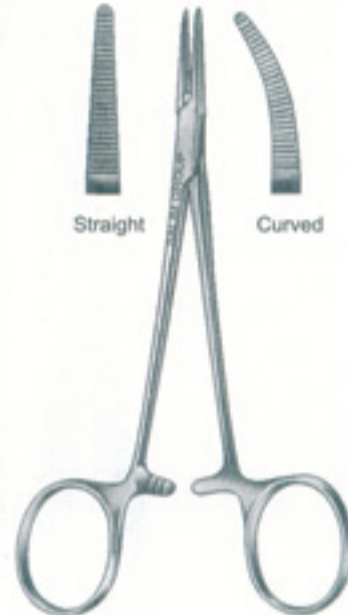

786-437
Halsted-Mosquito
12,5 cm

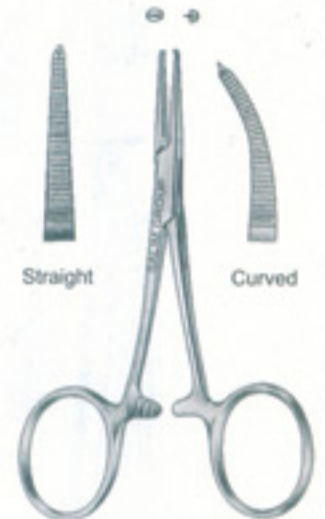

786-438
Baby-Mosquito
10 cm

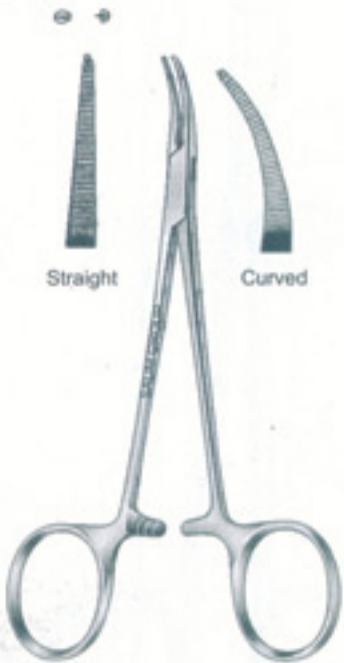

786-439
Micro-Halsted
12,5 cm

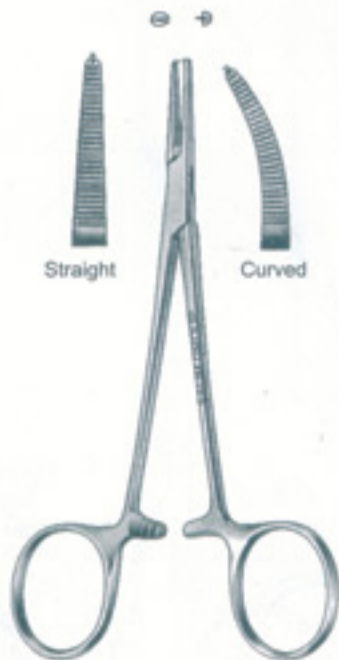

786-440
Halsted-Mosquito
12,5 cm

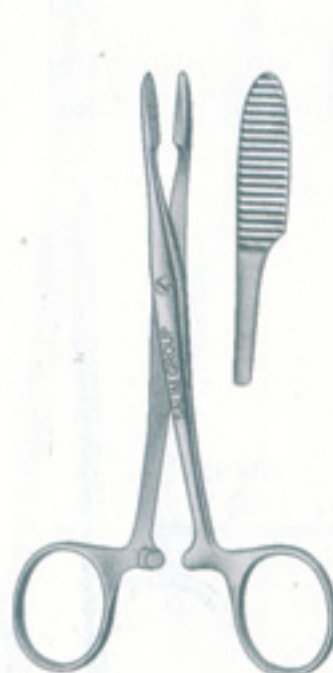

786-441
Pean
12,5 cm, 5"

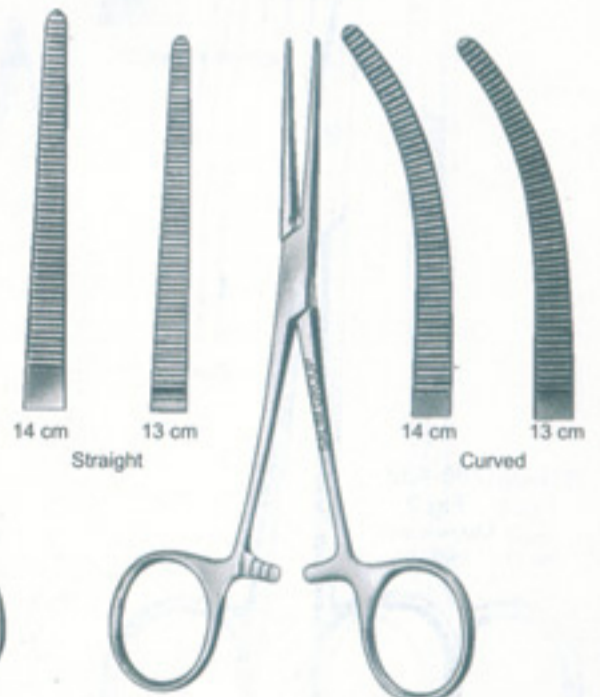

786-442
Pean
13 cm

HAEMOSTATIC FORCEPS

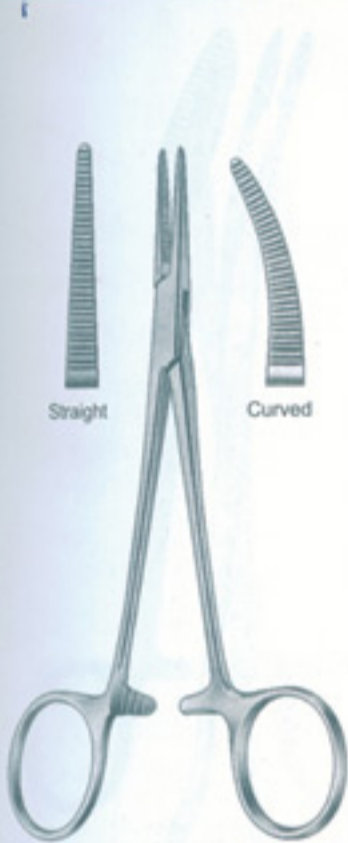

786-443
Baby-Crile (Pean)
14 cm

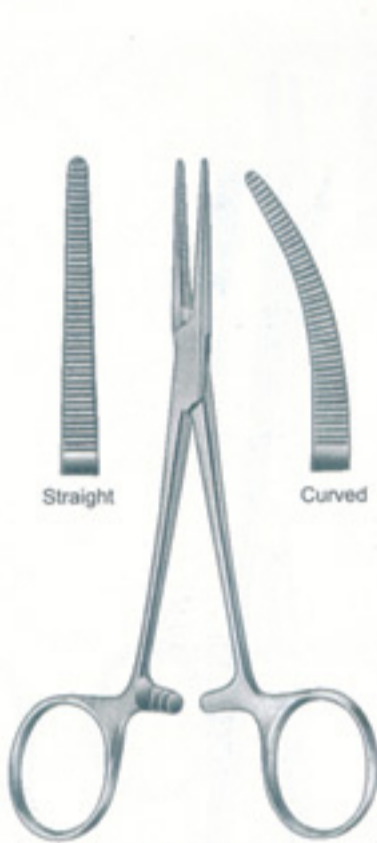

786-444
Crile
14 cm

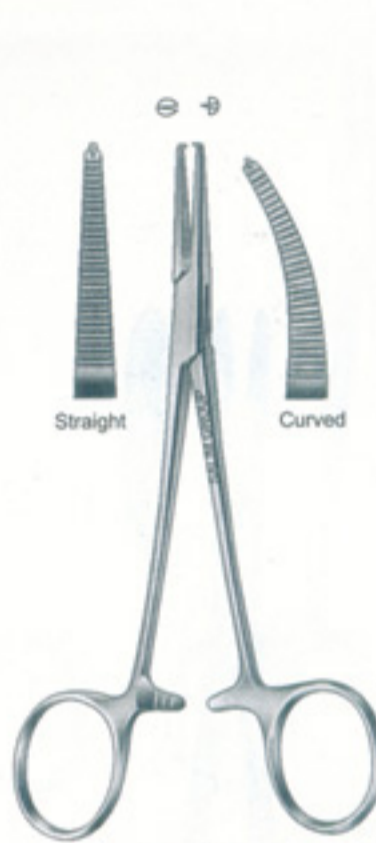

786-445
Baby-Crile (Kocher)
14 cm

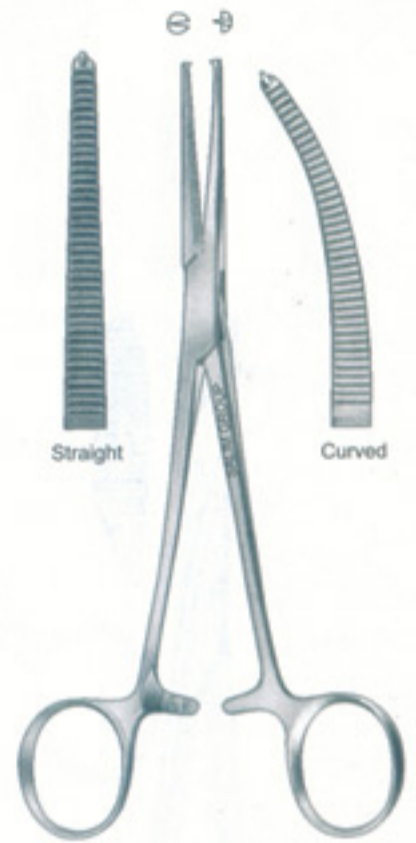

786-446
Crile (Kocher)
16 cm

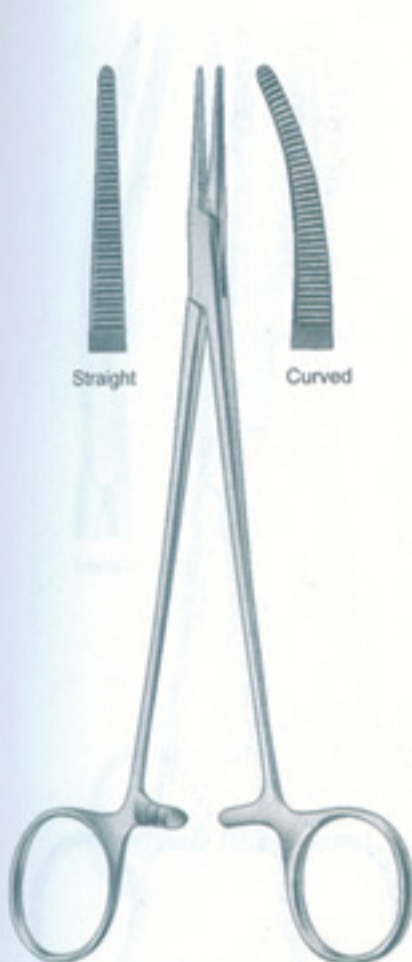

786-447
Halsted
18,5 cm.

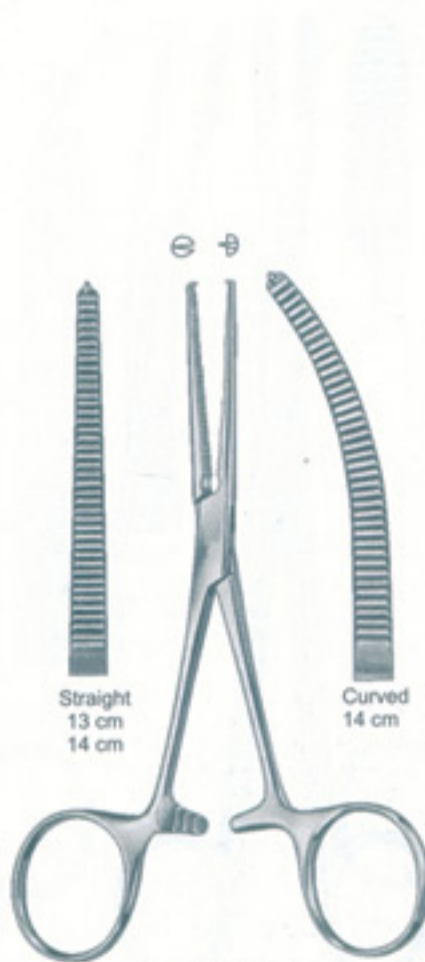

786-448
Kocher

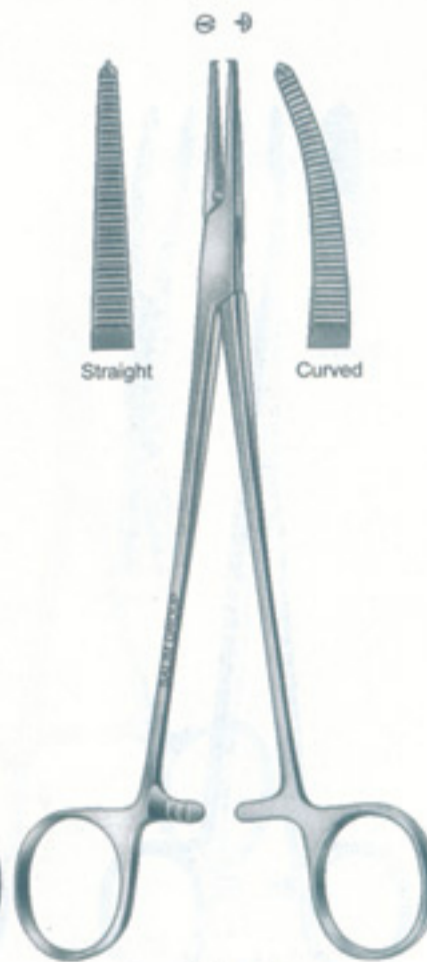

786-449
Halsted
18,5 cm

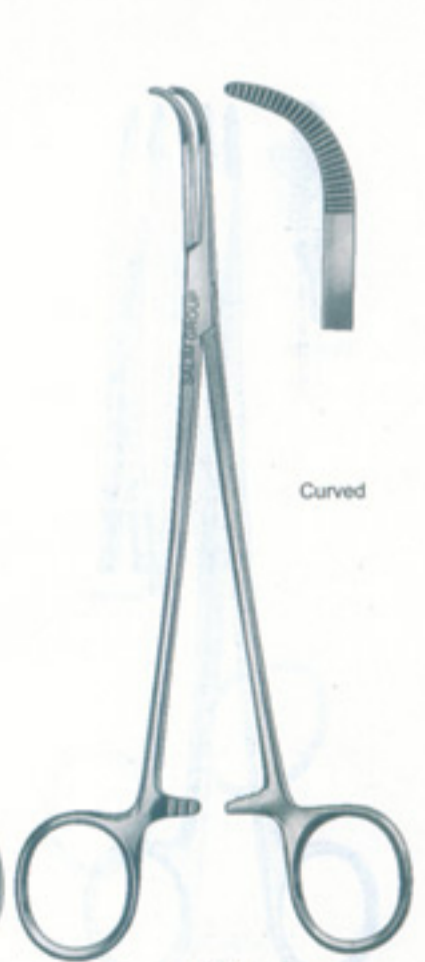

786-450
Baby-Mixter
18 cm



SALIM
Group Of Industries

SPONGE AND DRESSING FORCEPS

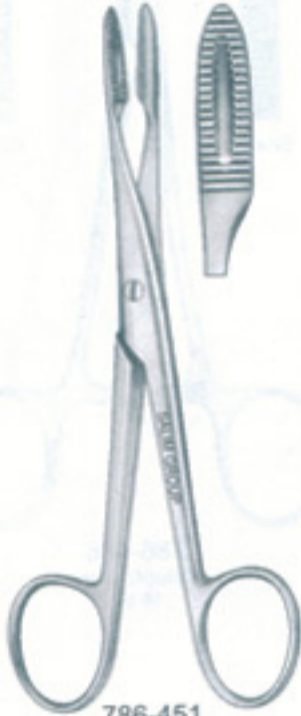

786-451
Without Ratchet
14,5 cm



786-452
With Ratchet
14,5 cm

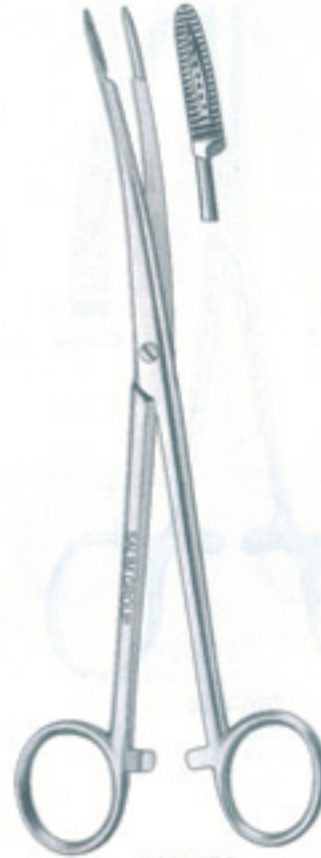

786-453
Curved
17,5 cm



786-454
Curved
21 cm

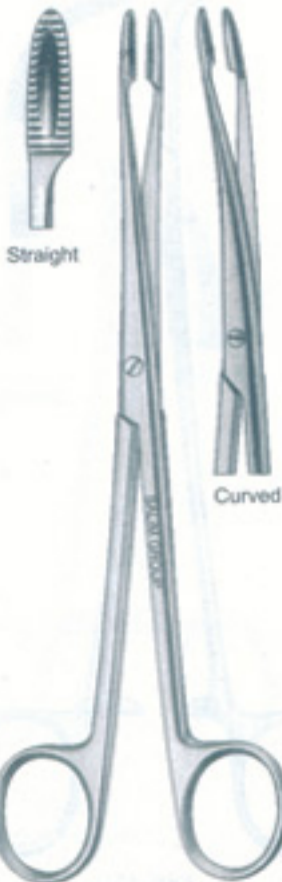

786-455
Without Ratchet
18 cm

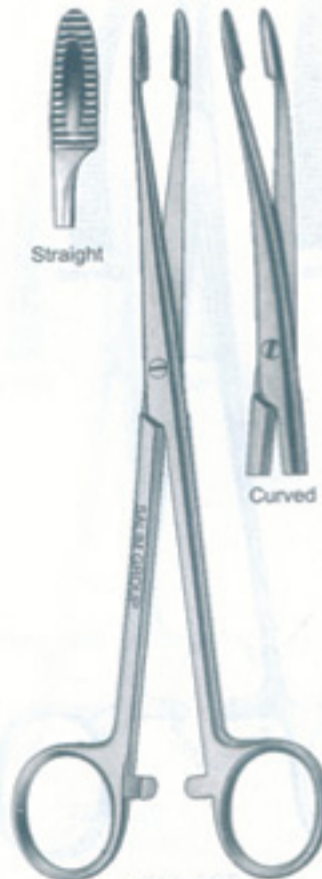

786-456
With Ratchet
18 cm

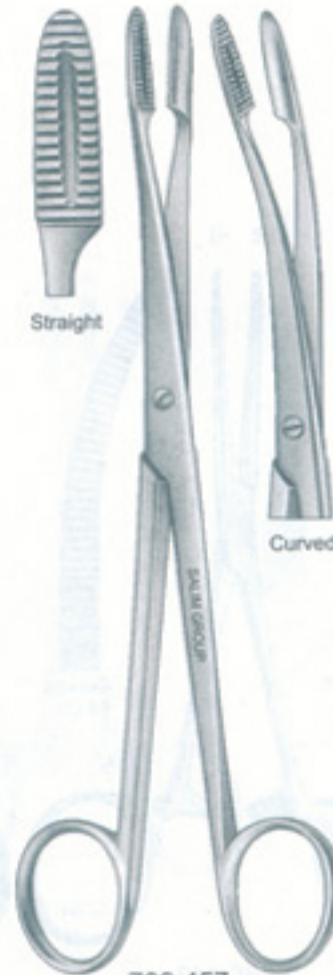

786-457
Without Ratchet
20 cm

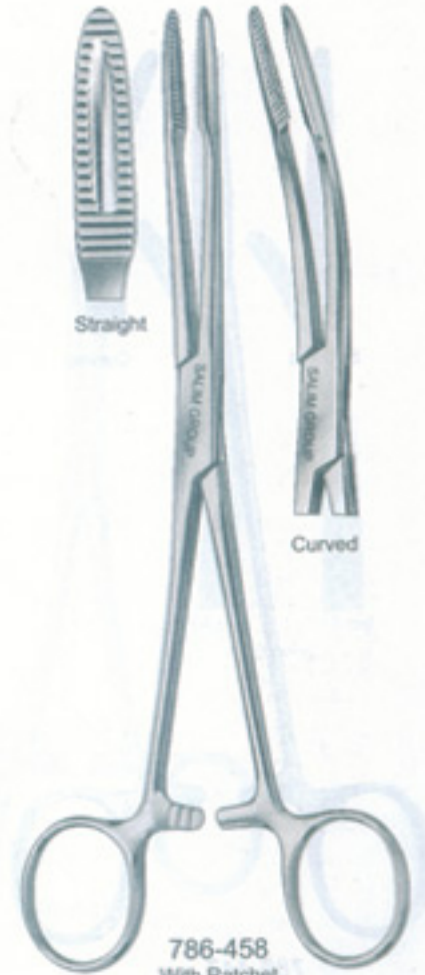

786-458
With Ratchet
20 cm

NEEDLE HOLDERS

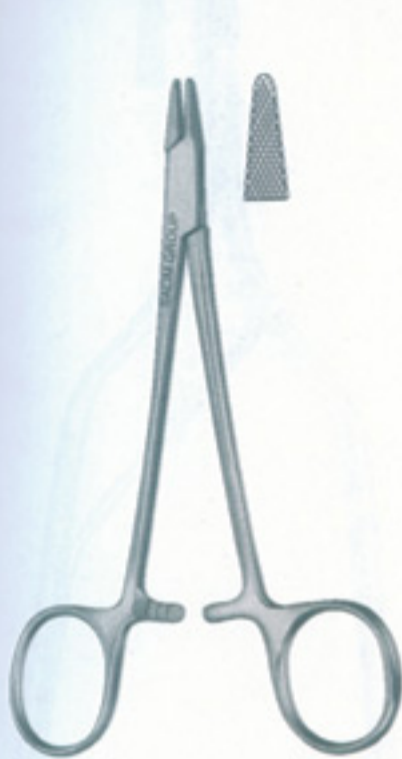

786-459
Baumgartner
14.5 cm



786-460
Crile-Murray
15 cm



786-461
Mayo-Hegar

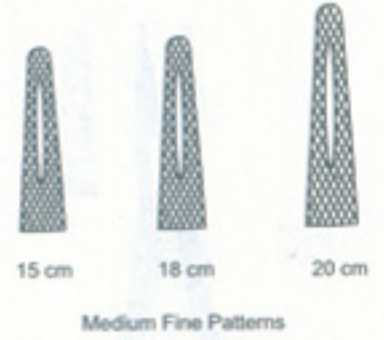

Designed for Frontal & Palate Suture

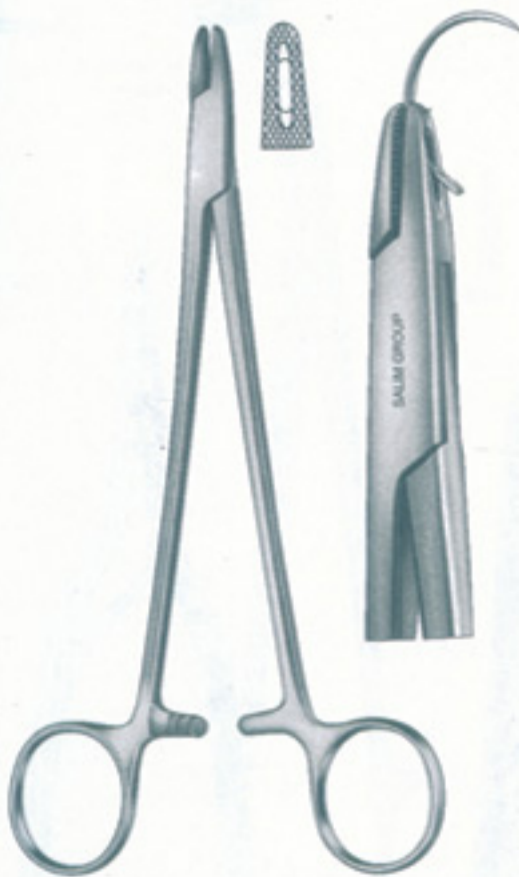

786-462
Adson
17.5 cm

Needle holders with Scissors

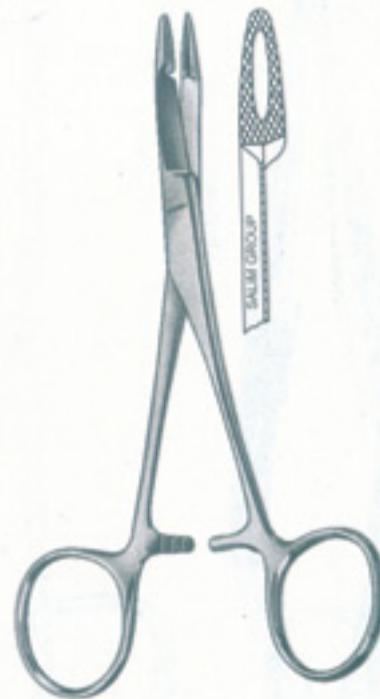

786-463
Heger-Olson
14 cm

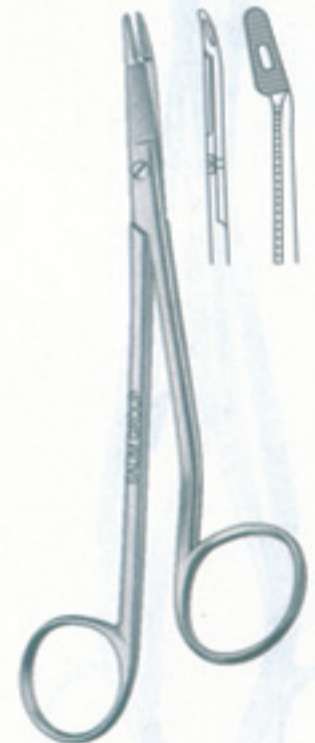

786-464
Gillies
15 cm



SALIM
Group Of Industries

NEEDLE HOLDERS

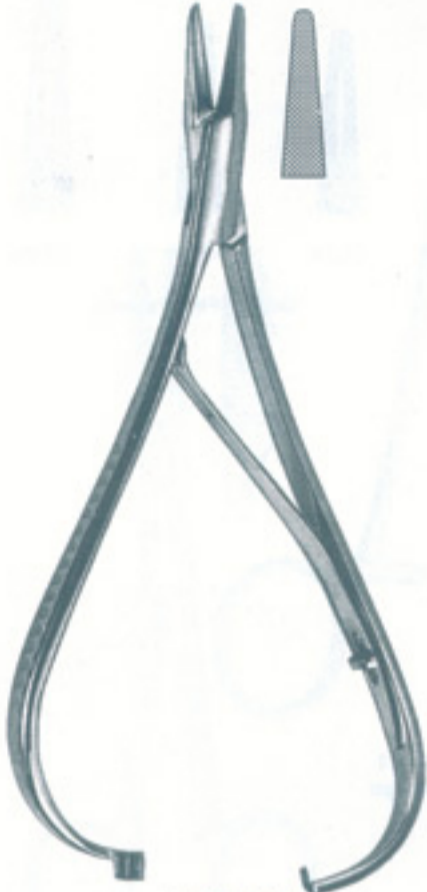

786-465
Mathieu
14 cm,

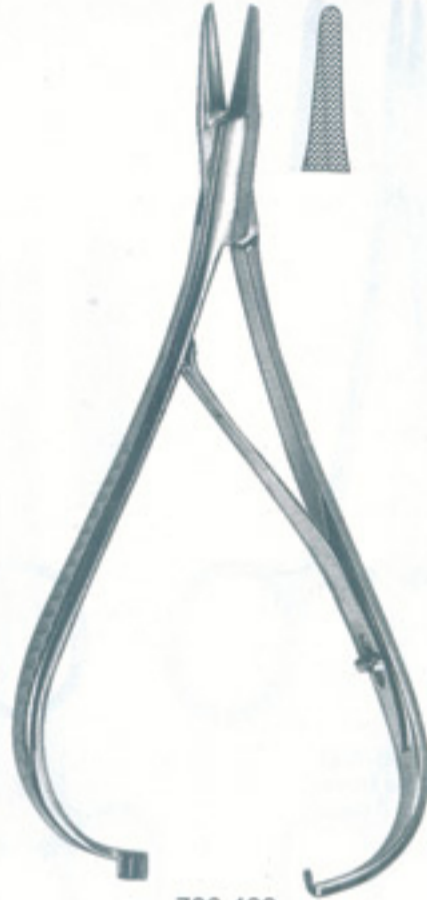

786-466
Mathieu
14 cm,

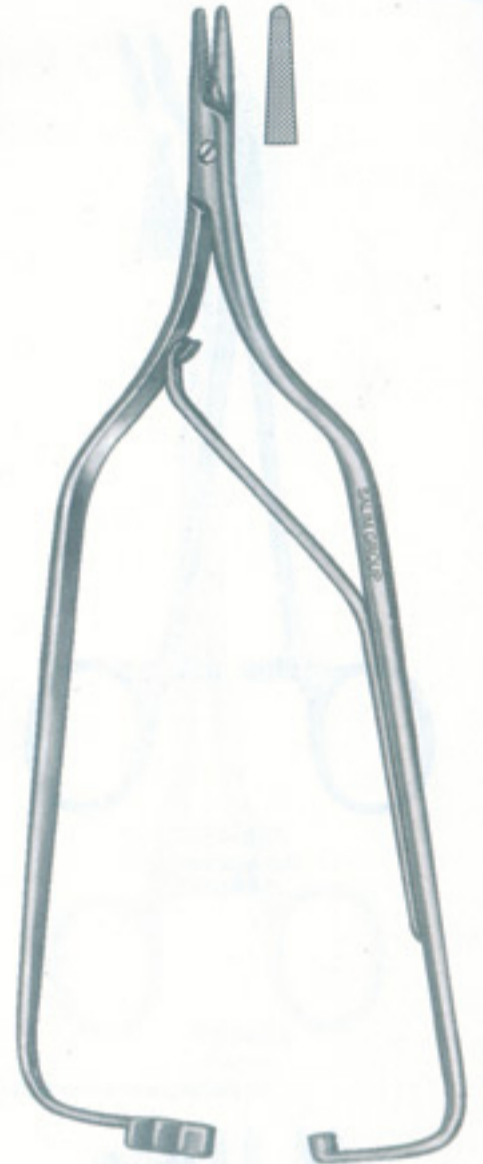

786-467
Boynton
12 cm,



786-468
Castroviejo
14 cm,



786-469
Castroviejo
14 cm,



786-470
Castroviejo
13 cm,



786-471
Arruga
16 cm,

TOWEL CLAMPS STERILIZING FORCEPS FOR STERILE INSTRUMENTS

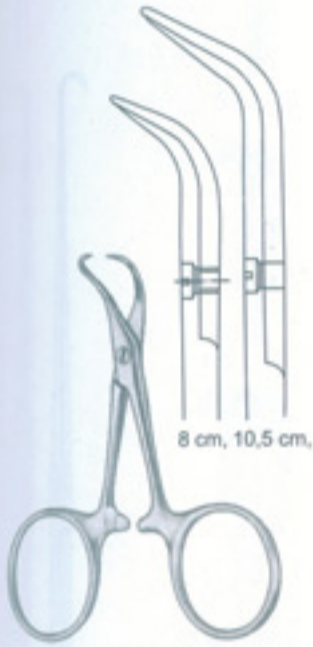

786-472
Backhaus

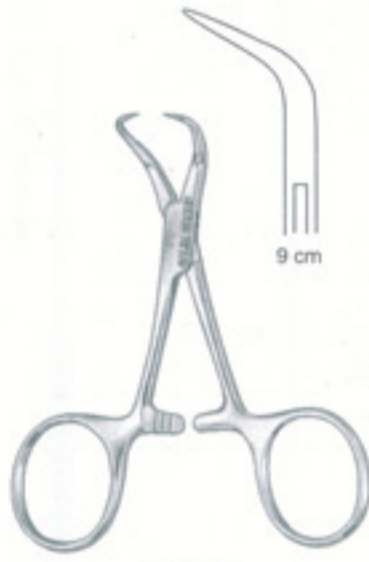

786-473
Backhaus

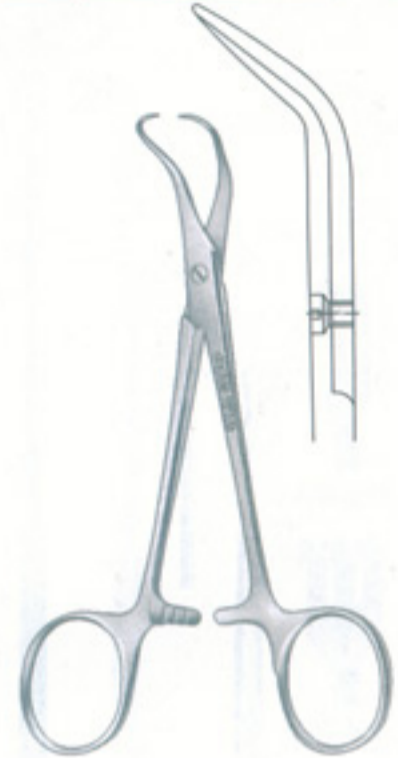
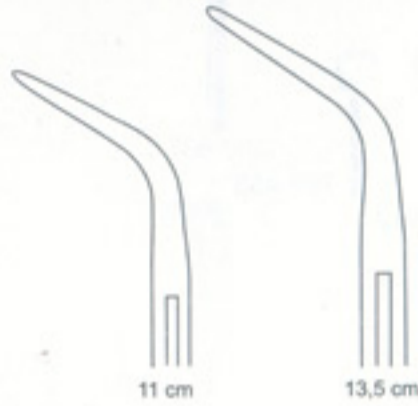

786-474
Backhaus-Kocher
13.5 cm



786-475
16 cm

786-476
Cheattle
28 cm

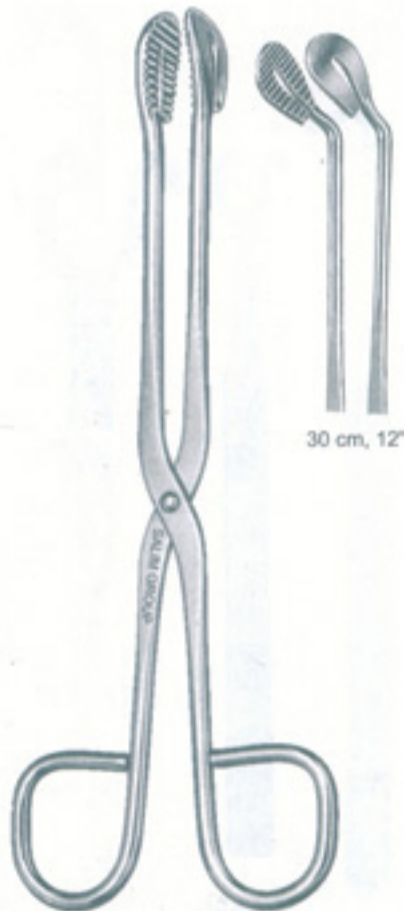

786-477
20 cm

30 cm, 12"



786-478
20 cm, 8"
30 cm, 12"



786-479
Rogge
23.5 cm



SALIM
Group Of Industries

SKIN HOOK & RETRACTORS

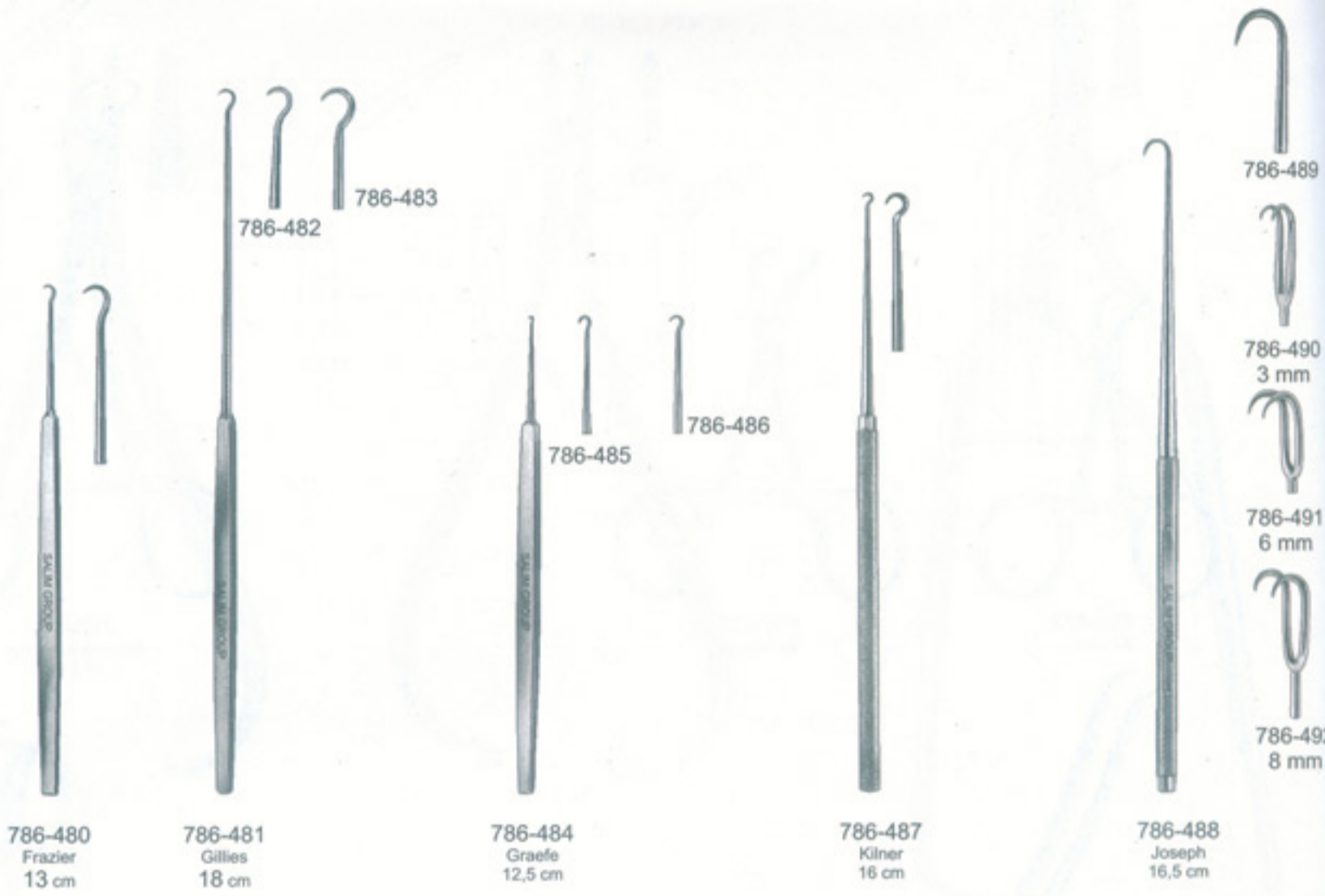

786-480
Frazier
13 cm

786-481
Gillies
18 cm

786-484
Graefe
12,5 cm

786-487
Kilner
16 cm

786-488
Joseph
16,5 cm

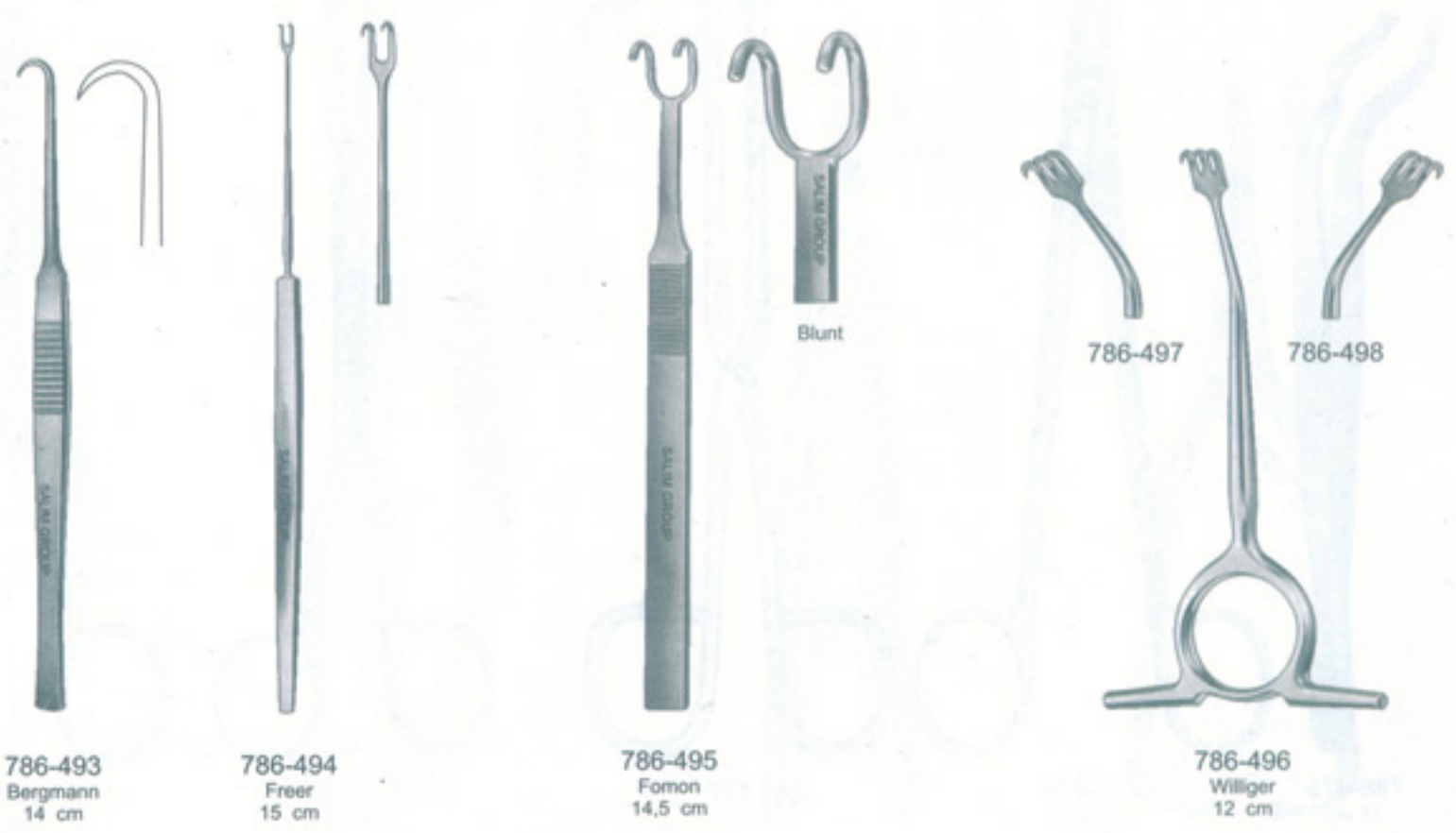

786-493
Bergmann
14 cm

786-494
Freer
15 cm

786-495
Fomon
14,5 cm

786-496
Williger
12 cm

RETRACTORS





SALIM
Group Of Industries

RETRACTORS

25 x 10 mm
22 x 10 mm

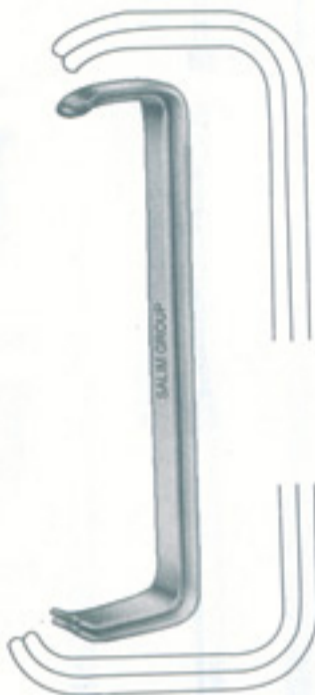

28 x 12 mm
32 x 12 mm
786-523
Farabeuf
12,5 cm

23 x 16 mm
20 x 16 mm

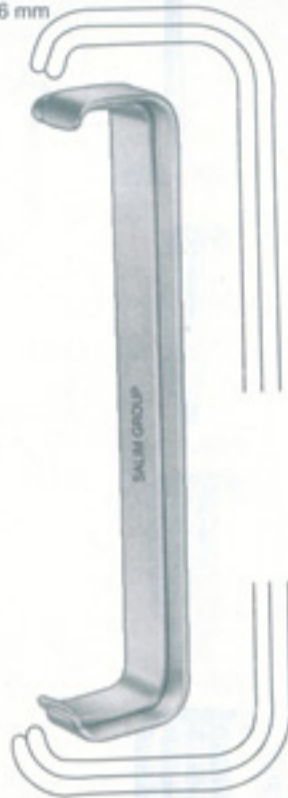

24 x 16 mm
28 x 16 mm
786-524
Farabeuf
15 cm



786-525
Roux - Set
16,5 cm
Consisting of
786-526 19 x 22 mm
23 x 30 mm
786-527 25 x 26 mm
28 x 38 mm
786-528 28 x 29 mm
33 x 45 mm

29 mm
26 mm
22 mm



28 mm
38 mm
45 mm



786-529
30 x 10 mm



786-529
Langenbeck
23 cm



786-532
25 x 6 mm



786-533
35 x 8 mm



786-530
40 x 10 mm



786-534
35 x 11 mm



786-531
43 x 13 mm



786-535
35 x 15 mm



786-536
41 x 11 mm



786-537
55 x 11 mm



786-532
Kocher-Langenbeck
21,5 cm

CHEEK RETRACTORS



786-538
Middelkorp



786-538
15x15 mm
22 cm



786-539
20x22 mm
21,5 cm



786-540
28x28 mm
23,5 cm



786-541
Greene
22,5 cm



786-542
Buchs
20,5 cm



786-543
Langerbeck
21 cm



786-543
28x10 mm



786-544
28x14 mm



786-545
33x14 mm



786-546
28x16 mm



786-547
40x10 mm



786-548
40x13 mm



786-549
Kocher
21 cm

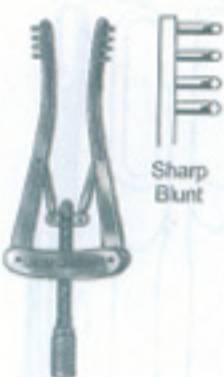

786-550
Alm
7 cm

Sharp
Blunt



786-551
Alm
10 cm

Sharp
Blunt



SALIM
Group Of Industries

ELEVATORS

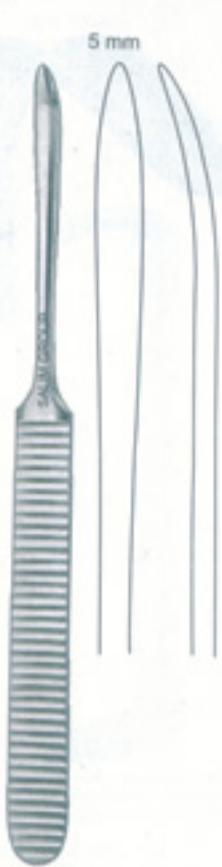

786-552
Williger
16,5 cm

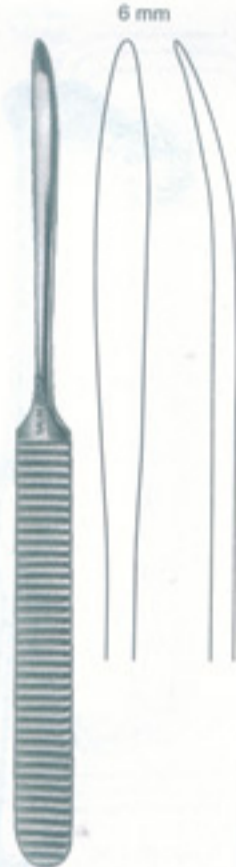

786-553
Williger
17 cm



786-554
Konig
15,5 cm



786-555
Konig
15,5 cm



786-556
Freer
19 cm



786-557
Freer
18,5 cm

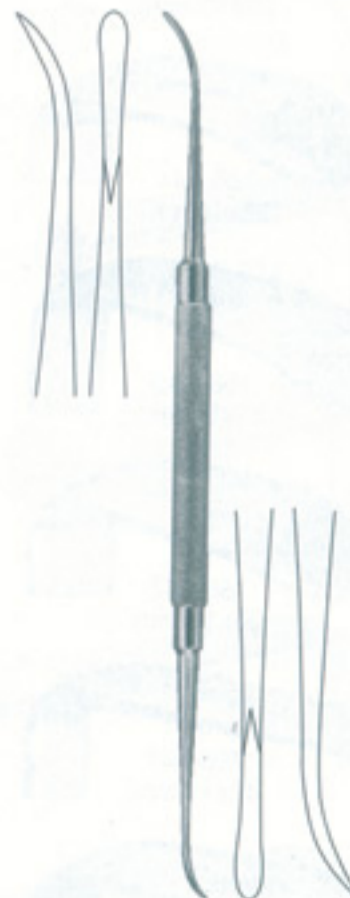

786-558
Freer-Yasargin
18,5 cm



786-559
Kendzia
17 cm

RASPATORIES

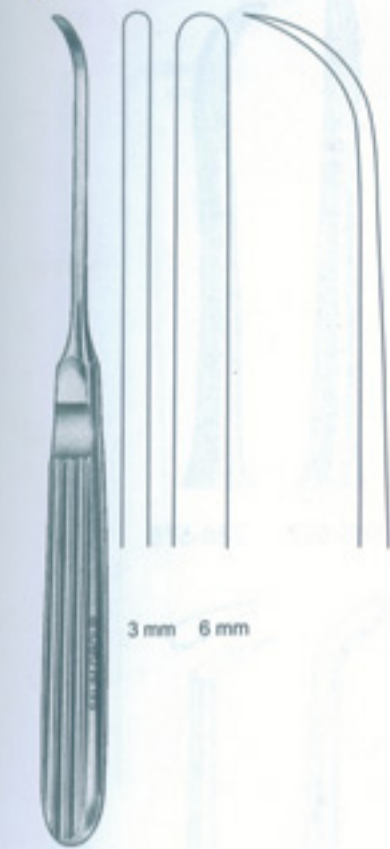

786-560 3 mm
786-561 6 mm
17 cm

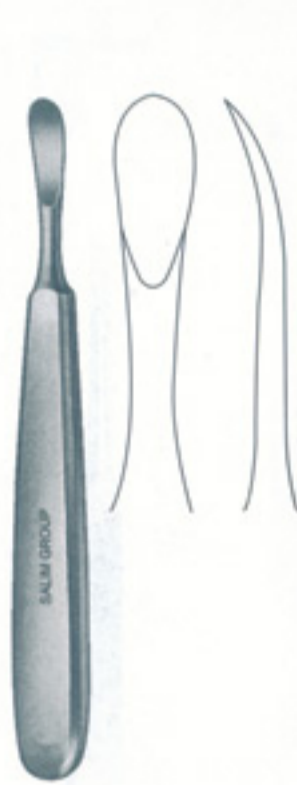

786-562 8 mm
Trelat
14 cm



786-563
Konig
15,5 cm

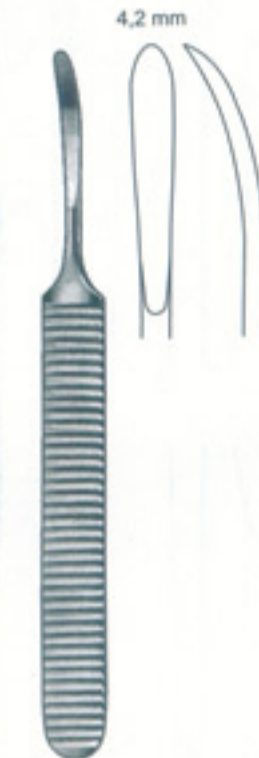

786-564
Williger
14 cm



786-565
Williger
16 cm



786-566 6 mm
16,5 cm

786-567 6 mm
786-568 8 mm

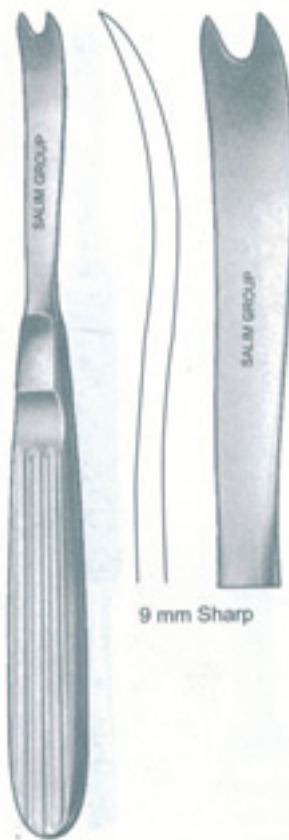

786-569
Obwegeser
17 cm



786-570
5 mm
20 cm



786-571
5 mm



786-572
8 mm



786-573
Tes786er
22 cm

6 mm
Bone Curette



SALIM
Group Of Industries

ELEVATORS



786-574
Saldin
19,5 cm

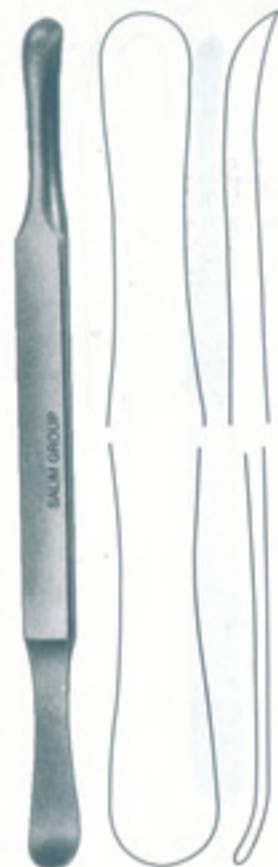

786-575
Saldin
19,5 cm



786-576
Chompret
15 cm



786-577 786-578



786-579 786-580



786-581
Freer
16 cm



786-582
Freer
16 cm



786-583
Partsch, mod
14,5 cm



786-584
Mead
16,5 cm



786-585
Mead
18 cm

STV CHISELS & GOUGES



786-586
Partsch
17 cm



786-587
Freer
16 cm



786-588
Freer
16 cm



786-589
Lucas
16 cm



786-590
Lucas
16 cm



786-591
Lambotte
12.5 cm



786-592
14 cm



786-593
Partsch
14 cm



786-594
Partsch
17 cm

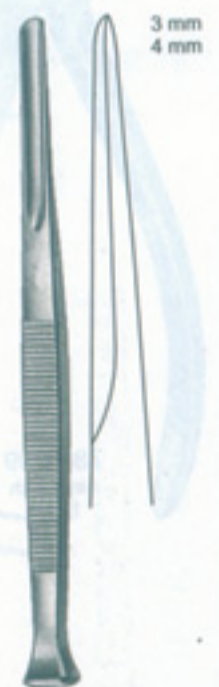

786-595
Partsch
14 cm



RUBBER DAM INSTRUMENTS

Calmp forceps



786-596
Ivory lightweight
17 cm

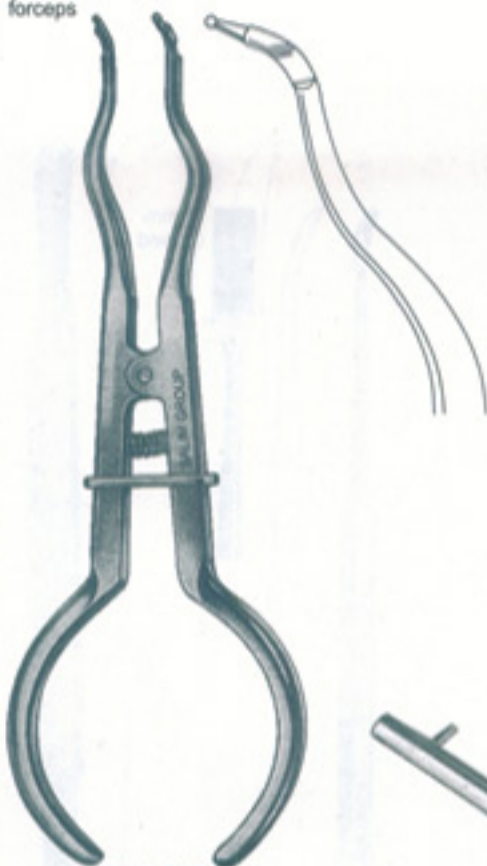

786-597
Brewer
17.5 cm

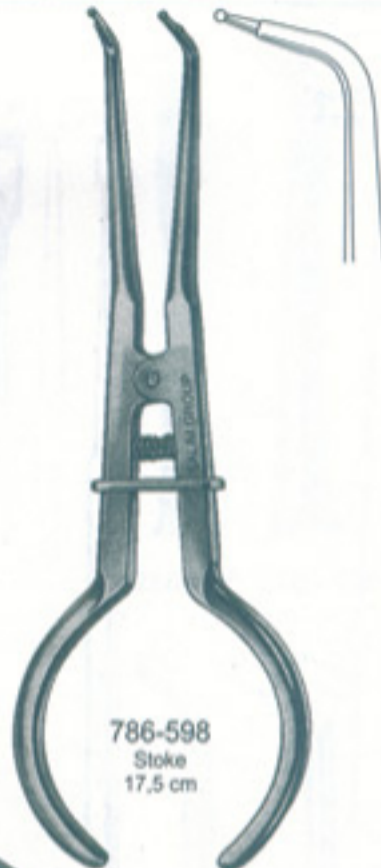

786-598
Stoke
17.5 cm

Punch forceps



786-599
Ainsworth
17 cm



786-600
Ivory
17 cm

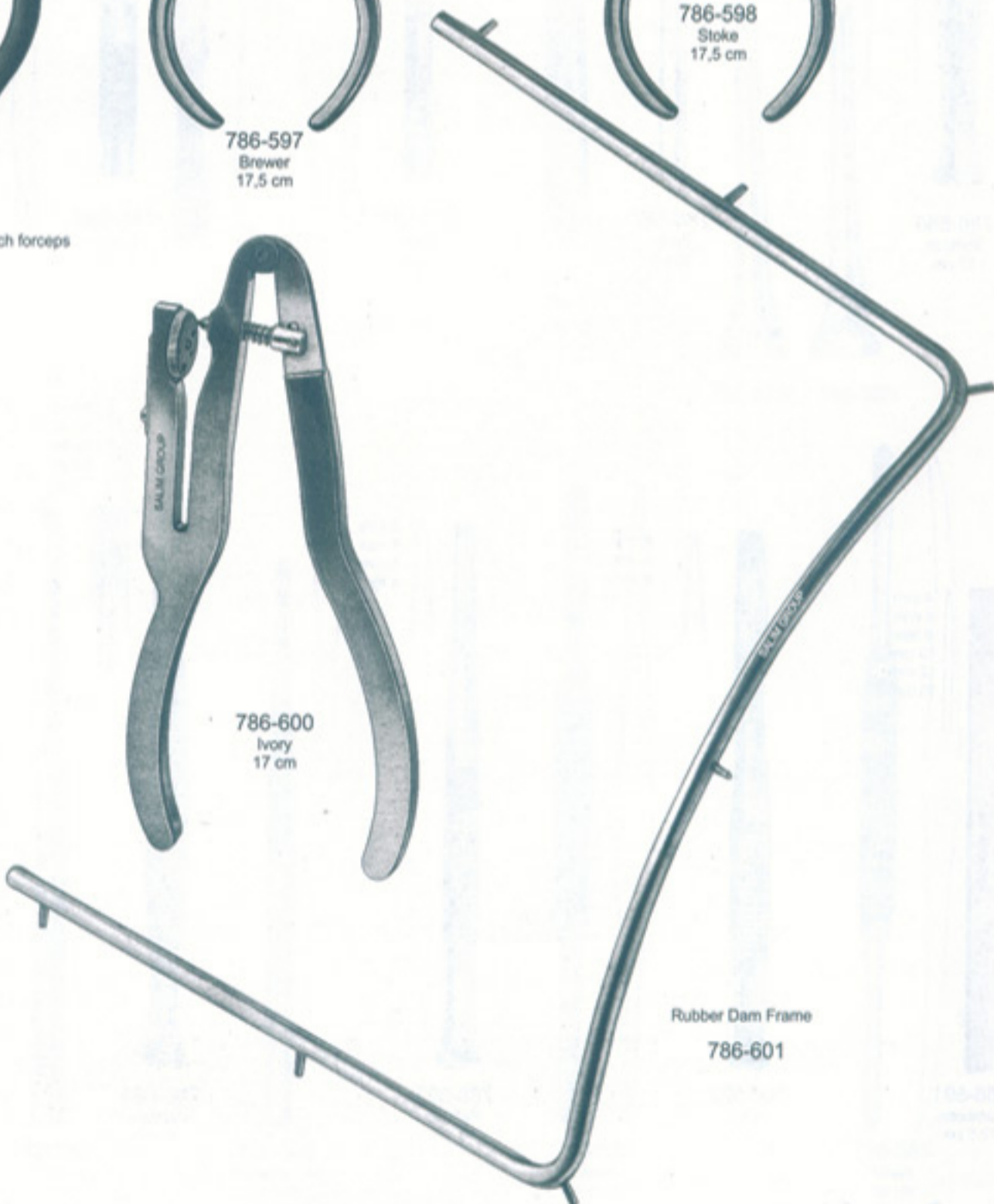

Rubber Dam Frame
786-601

TISSUE PLIERS

786-602
Fig.1
Adson
12 cm



786-603
Fig.1
Adson 1x2
12 cm



786-604
Fig.1
Semken-Taylor
12.5 cm



786-605
Fig.2
Semken-Taylor
12.5 cm



786-606
Fig.1
Semken-Taylor 1x2
12.5 cm



786-607
Fig.2
Semken-Taylor 1x2
12.5 cm



786-608
12 cm



786-609
11.5 cm



786-610
11.5 cm



786-611
11.5 cm





SALIM
Group Of Industries

COTTON AND DRESSING PLIERS

- 786-612
15 cm

Suture Plier

- 786-613
Fig.1
15 cm

Goldman-Fox
(Crane-Kaplane)

- 786-614
Fig.2
15 cm

Goldman-Fox
(Crane-Kaplane)

- 786-615
Fig.1
15 cm

Self-Locking

- 786-616
Fig.2
15 cm

Self-Locking

- 786-617
Fig.1
15 cm

Flagg

- 786-618
Fig.2
15 cm

London College

- 786-619
Fig.3
16 cm

Meriam

- 786-620
Fig.4
13 cm

Perry



- 786-621
Fig.18L
16 cm

self-Locking

- 786-622
Fig.2
16 cm

College

- 786-623
Fig.3
16 cm



MOUTH MIRRORS HANDLES FOR MOUTH MIRRORS



786-624
Plane 4
22 mm
Plane 5
24 mm



786-625
Magnifying 4
22 mm
Magnifying 5
24 mm



786-626
Plane 4
22 mm
Plane 5
24 mm

With cone-socket



786-627
Magnifying 4
22 mm
Magnifying 5
24 mm



786-628



786-629
Hollow



786-630



786-631
Hollow



SALIM
Group Of Industries

SCALPEL HANDLES



786-632
Fig. 3L



786-633
Fig. 7



786-634
Fig. 5



786-635
Fig. 5A



786-636
Fig. 3



786-637
Fig. 3G



786-638
Fig. 4

HANDLES REFERENCE GUIDE



A
786 angle ended
knurling round



B
Double ended
knurling round



C
786 angle ended
octangle serrated



D
Double ended
octangle serrated



E
786 angle ended
hollow round



F
Double ended
hollow round



G
Double ended
hollow round grooved



H
Double ended
Swiss pattern octangle

Note:
If you have preference different from the standard handle shown, please specify the optional handle number when ordering. If the tip/handle combination you desire is not shown, we will be glad to provide you with a quote for its preparation.



SALIM
Group Of Industries

EXPLORERS ENDODONTIC INSTRUMENTS



786-639
Fig.23



786-640
Fig.2



786-641
Fig.16



786-642
Fig.9



786-643
Fig.10



786-644
Fig.12



786-645
Fig.11



786-646
Fig.6



786-647
Fig.8



786-648
Fig.5



786-649
Fig.17



786-650
Fig.17A



786-651
Fig.3



786-652
Fig.3A



786-653
Fig.1
Spreader



786-654
Fig.2
Spreader



786-655
Fig.3
Spreader



786-656
Fig.4
Spreader



786-657
Fig.5
Spreader



786-658
Fig.6
Spreader



786-659
Fig.7
Spreader

PERIODONTAL POCKET PROBES
ENDODONTIC INSTRUMENTS

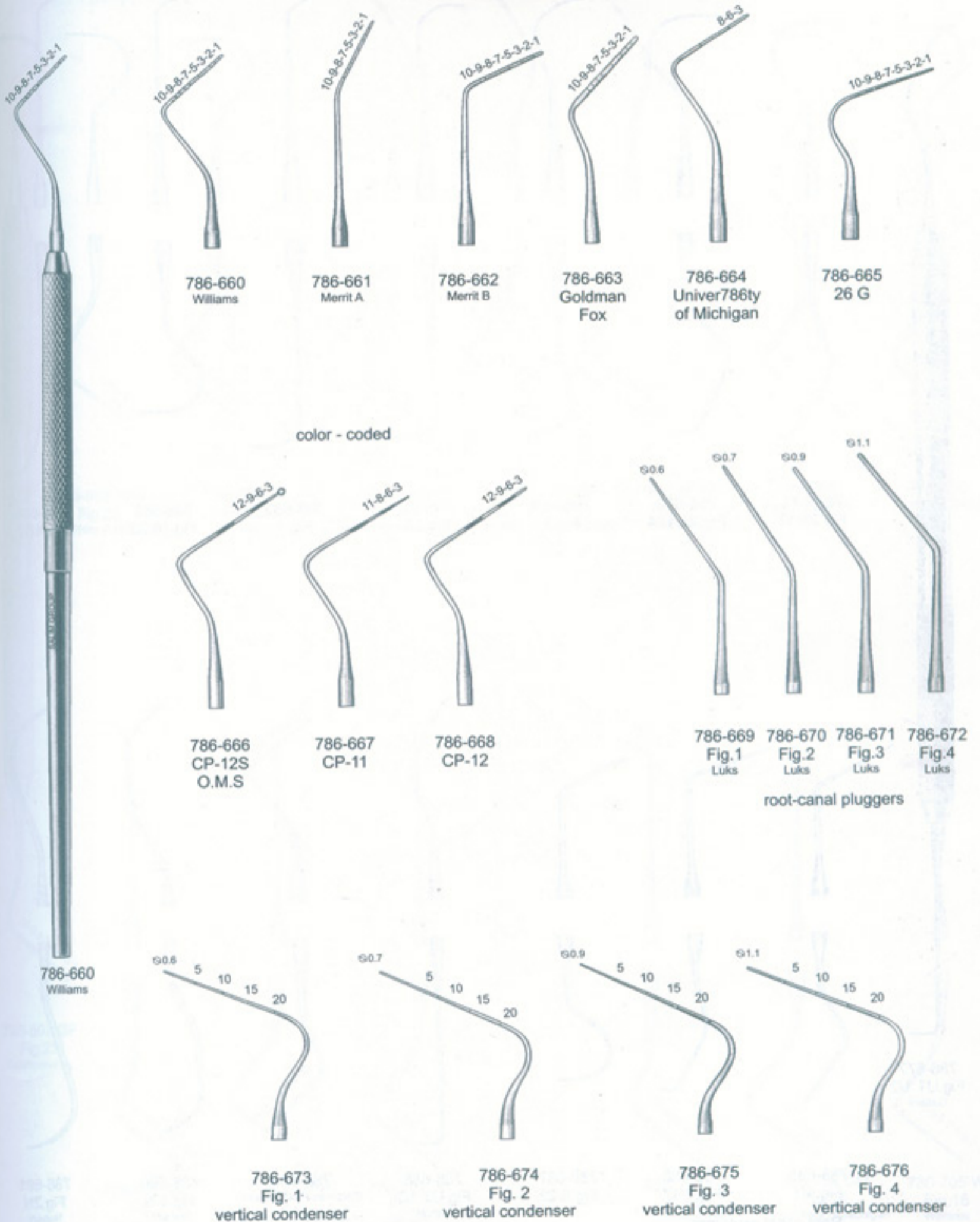



SALIM
Group Of Industries

EXPLORERS
PROBES

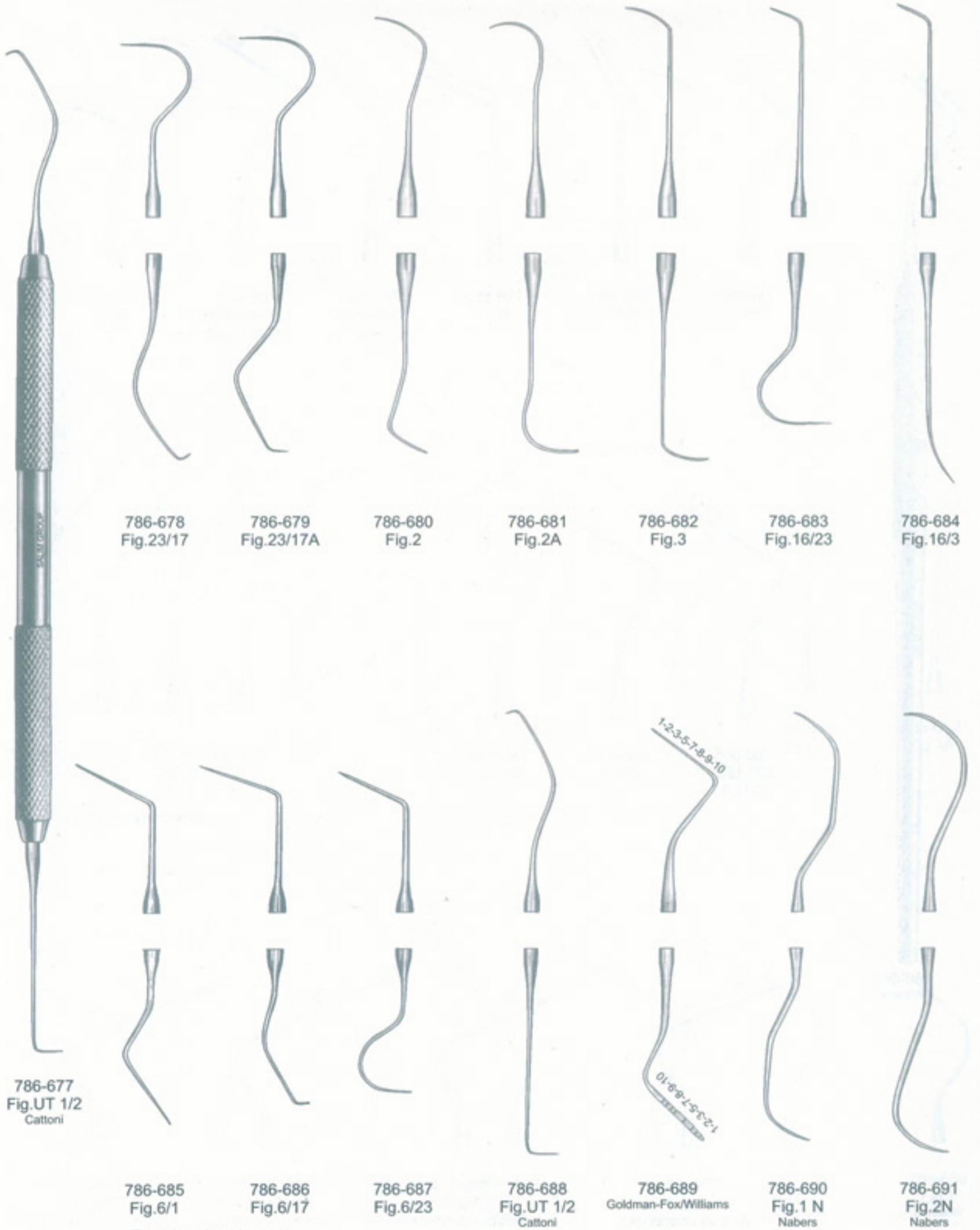

Root canal explorers

EXPLORERS ENDODONTIC INSTRUMENTS

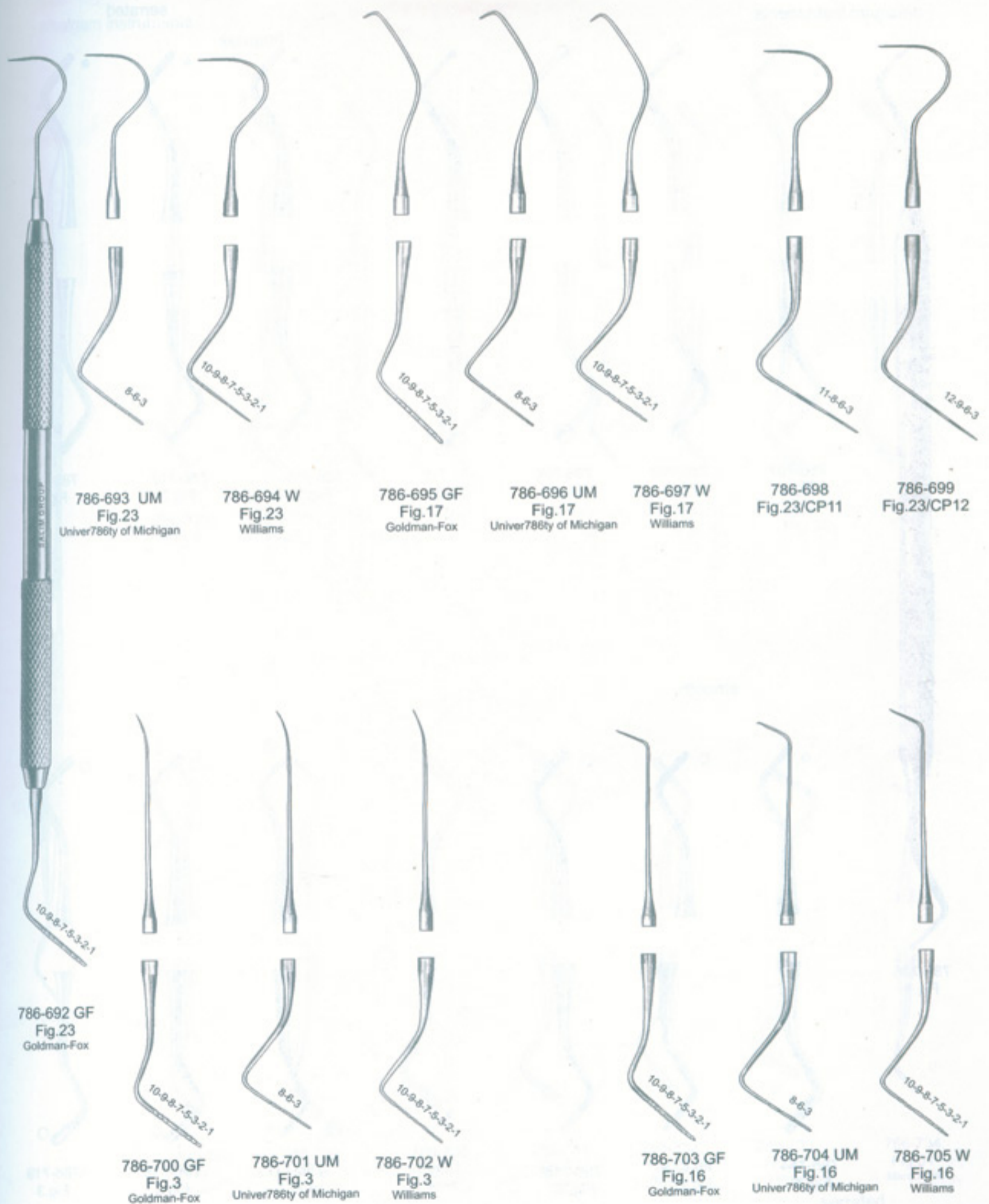



SALIM
Group Of Industries

FILLING INSTRUMENTS

amalgam instruments

serrated



786-706
Fig.1



786-707
Fig.2



786-708
Fig.3



786-709
Fig.4



786-710
Fig.5



786-711
Fig.1



786-712
Fig.2



786-713
Fig.3



smooth



786-714
Fig.1L



786-715
Fig.2L



786-716
Fig.3L



786-717
Fig.1



786-718
Fig.2



786-719
Fig.3



FILLING INSTRUMENTS

amalgam instruments

serrated

smooth

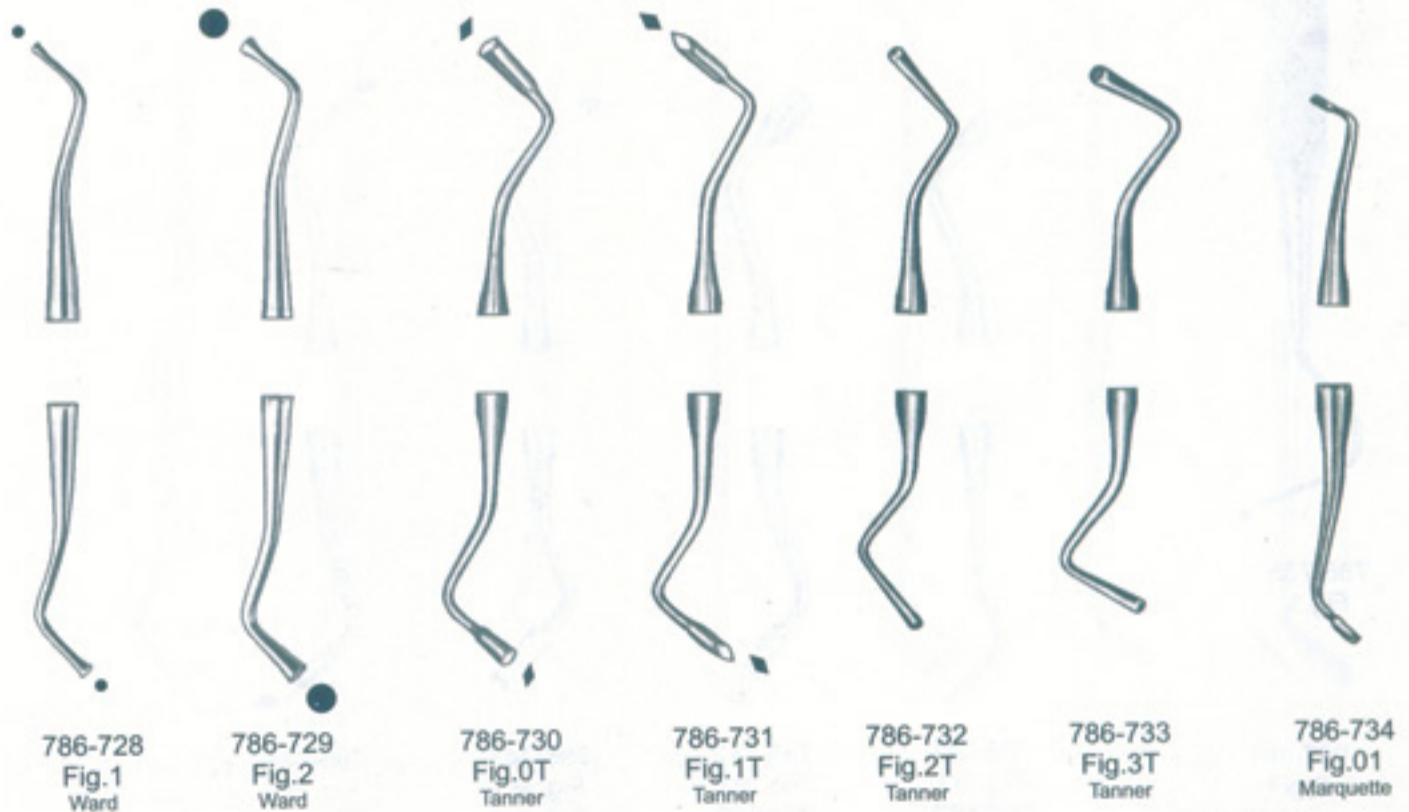
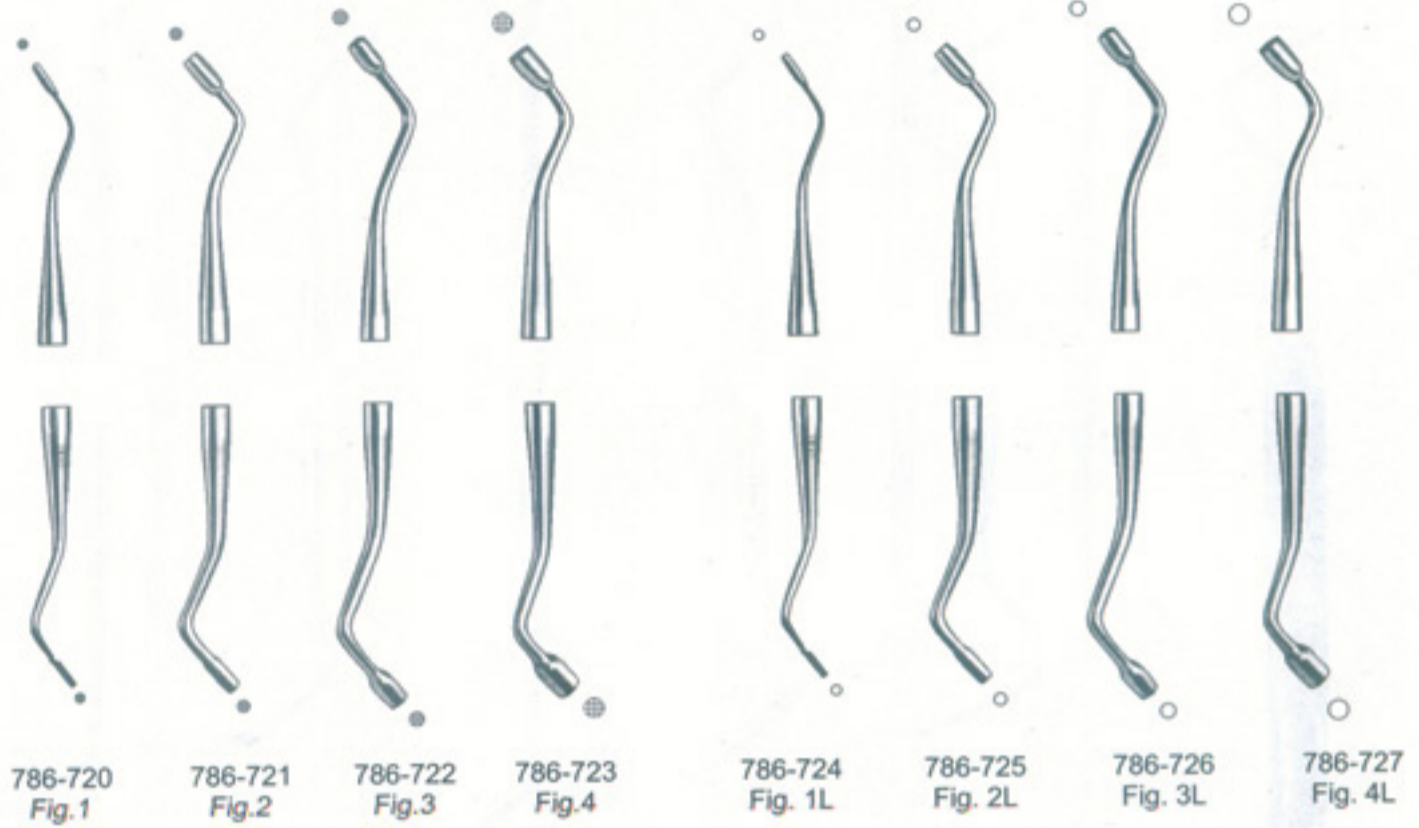

serrated



SALIM
Group Of Industries

FILLING INSTRUMENTS

amalgam instruments



786-735
Fig.1



786-735
Fig.1



786-736
Fig.2



786-737
Fig.3



786-738
Fig.4



786-739
Fig.5



786-740
Fig.6

set of 6 pieces



786-741
Fig. H1
Hollenback



786-742
Fig. H2
Hollenback



786-743
Fig. H3
Hollenback



786-744
Fig. H4
Hollenback



FILLING INSTRUMENTS
PLASTIC FILLING INSTRUMENTS

Burnishers

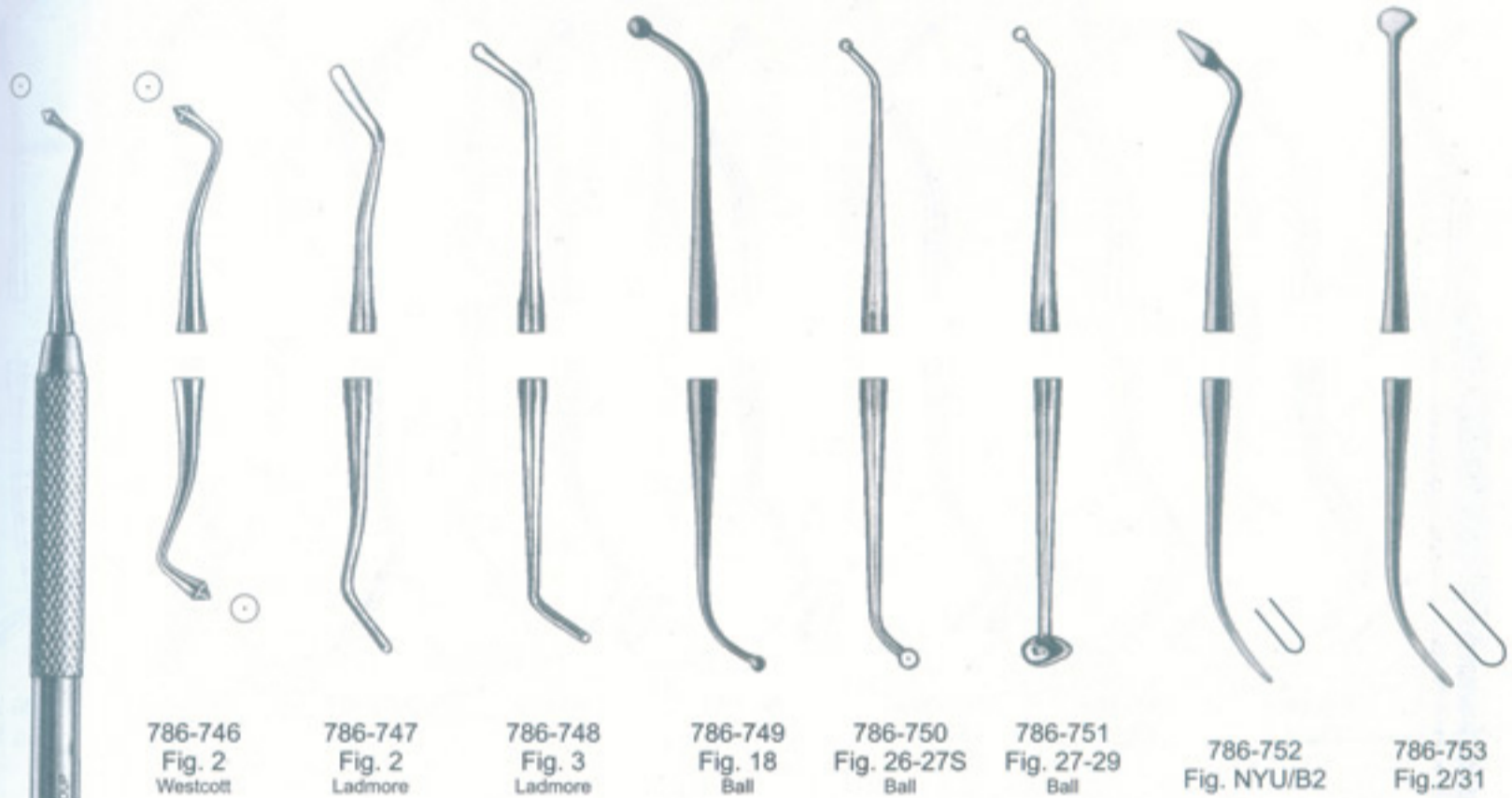

plastic filling instruments

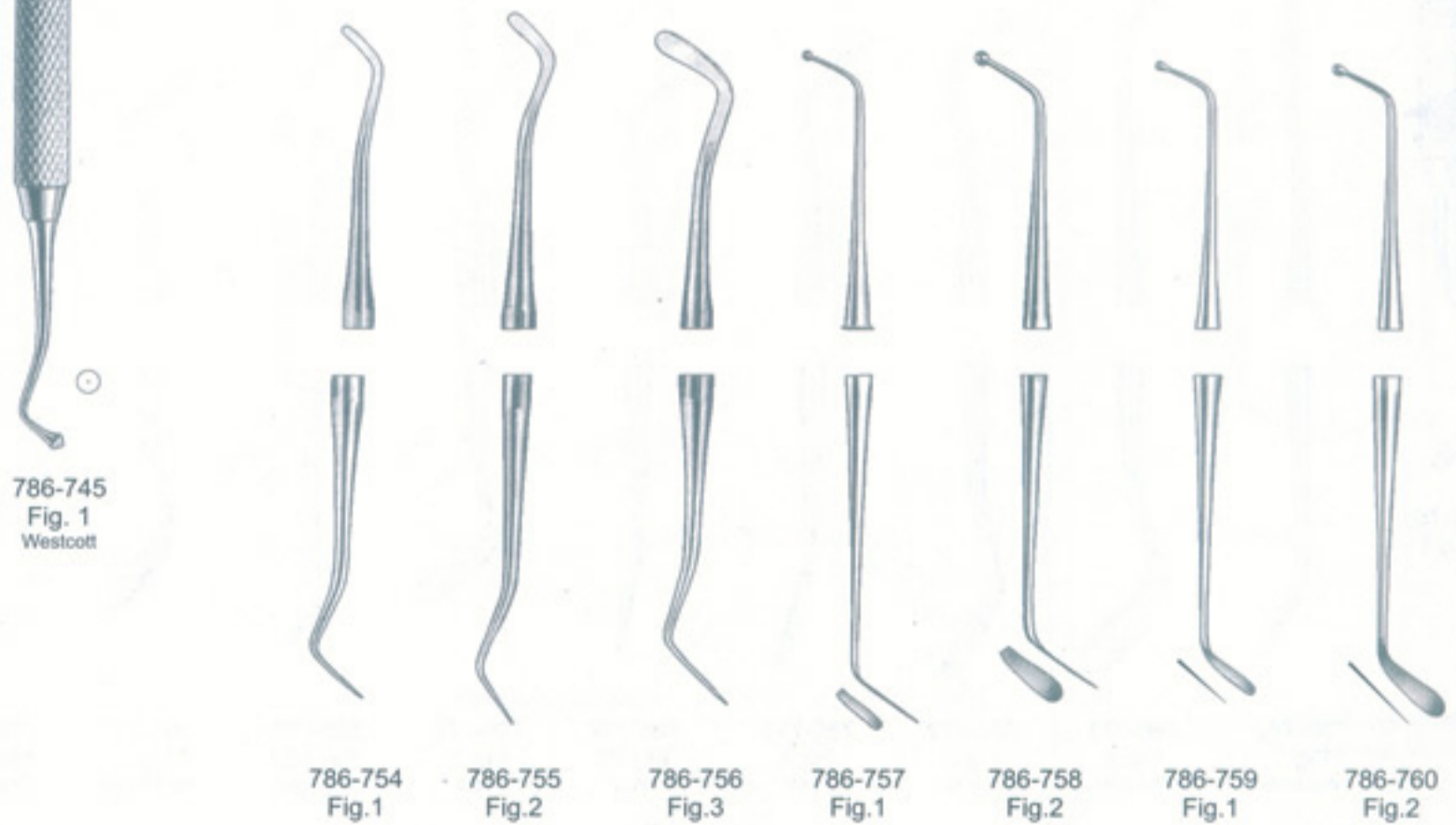

PLASTIC FILLING INSTRUMENTS AMALGAM CARVERS

SALIM
Group Of Industries

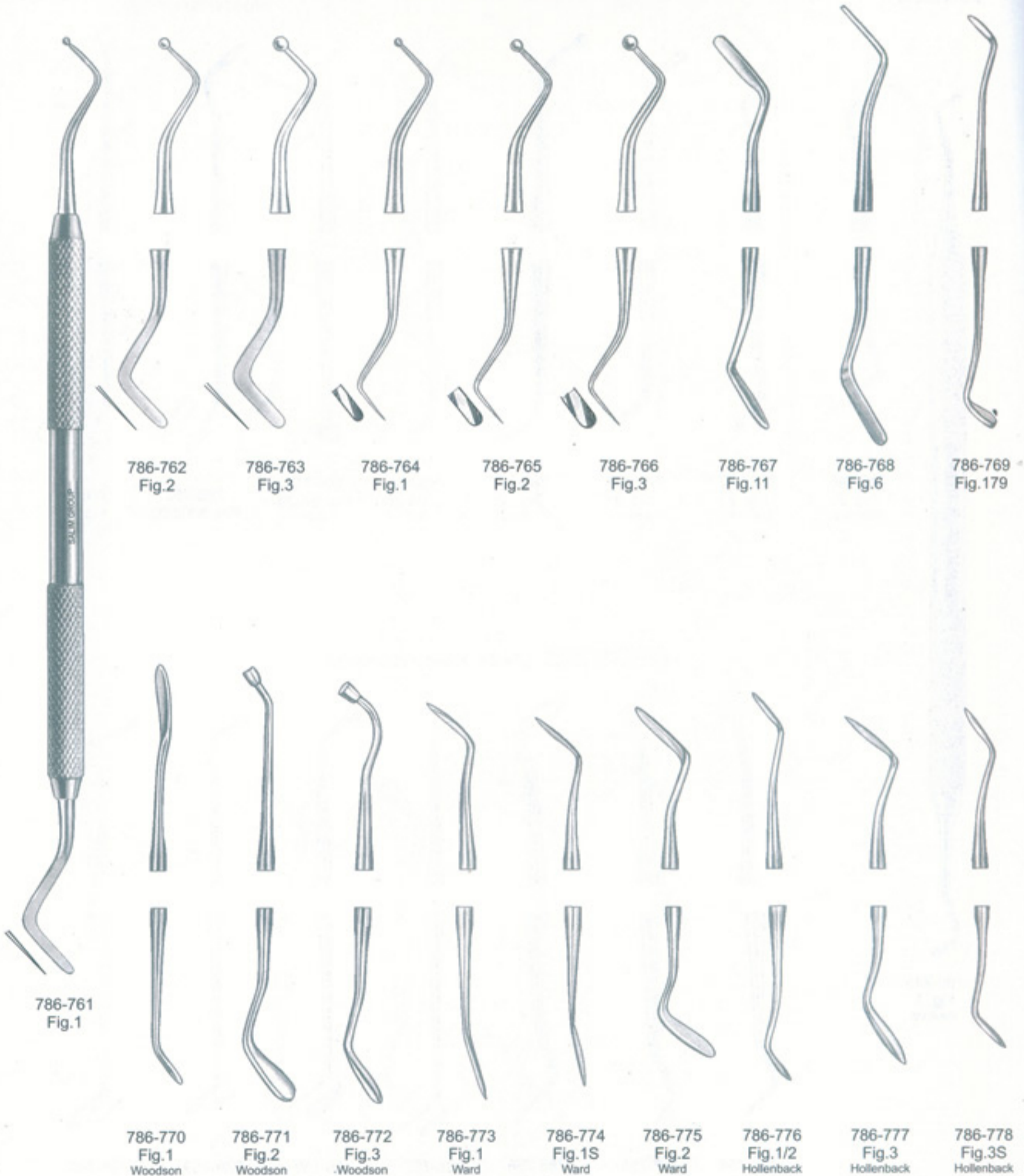

AMALGAM CARVERS OPERATIVE INSTRUMENTS



786-779
Fig.1
Farhm



786-780
Fig.2
USC



786-781
Fig.1
Interproximal



786-782
Fig.2
Interproximal
Off-Angle



786-783
Fig.SHO-A



786-784
Fig.3-SHO



786-785
Fig.104



786-786
Fig.8
Willard



786-787
Fig.1



786-788
Fig.2



786-789
Fig.3



786-790
Fig.4



786-791



786-792



786-793

cleoids-discoids

Instrument For Subgingival Application
Of Tinctures And Medicaments



SALIM
Group Of Industries

CAVITY PREPARATION INSTRUMENTS

gingival margin trimmers

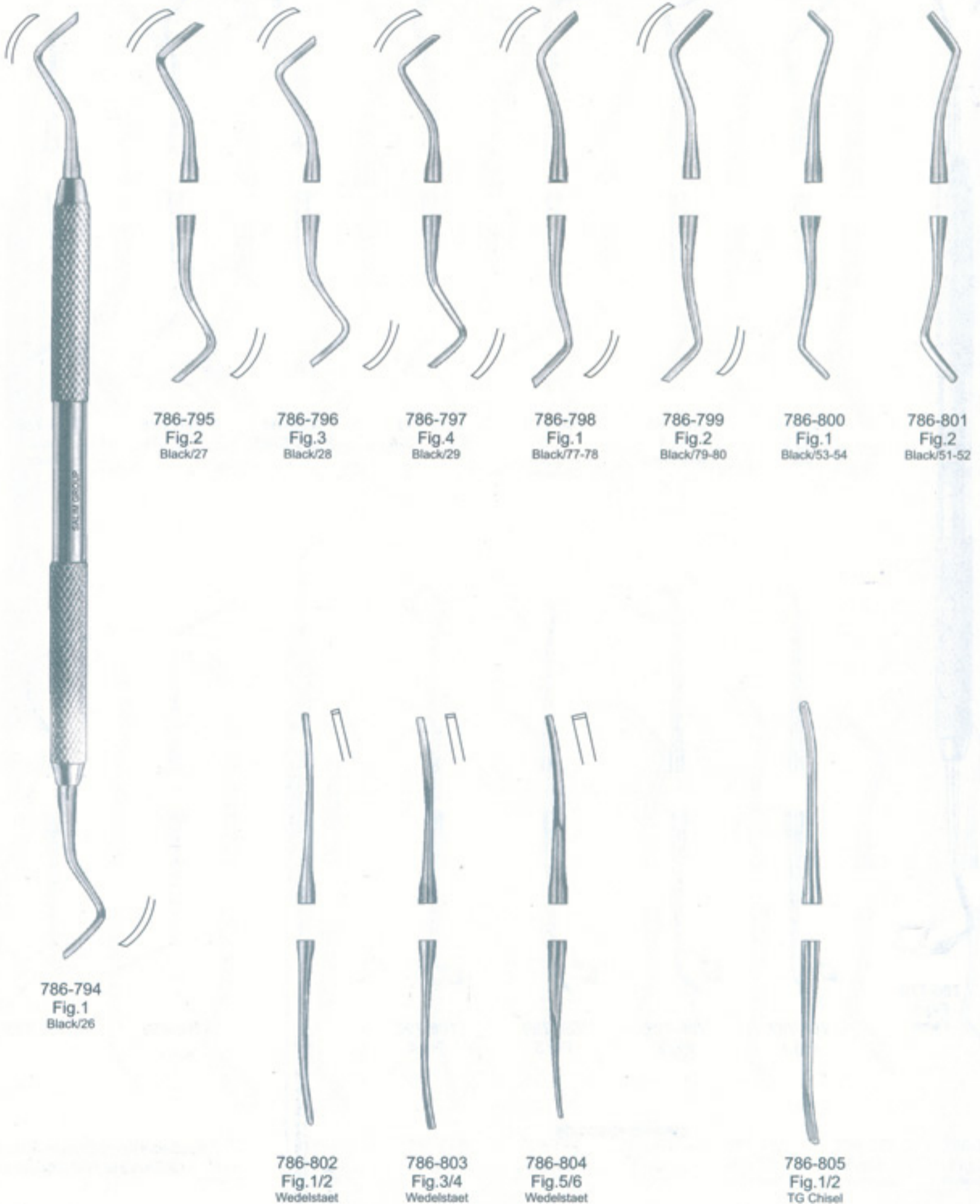

EXCAVATORS



786-806
Fig. 6

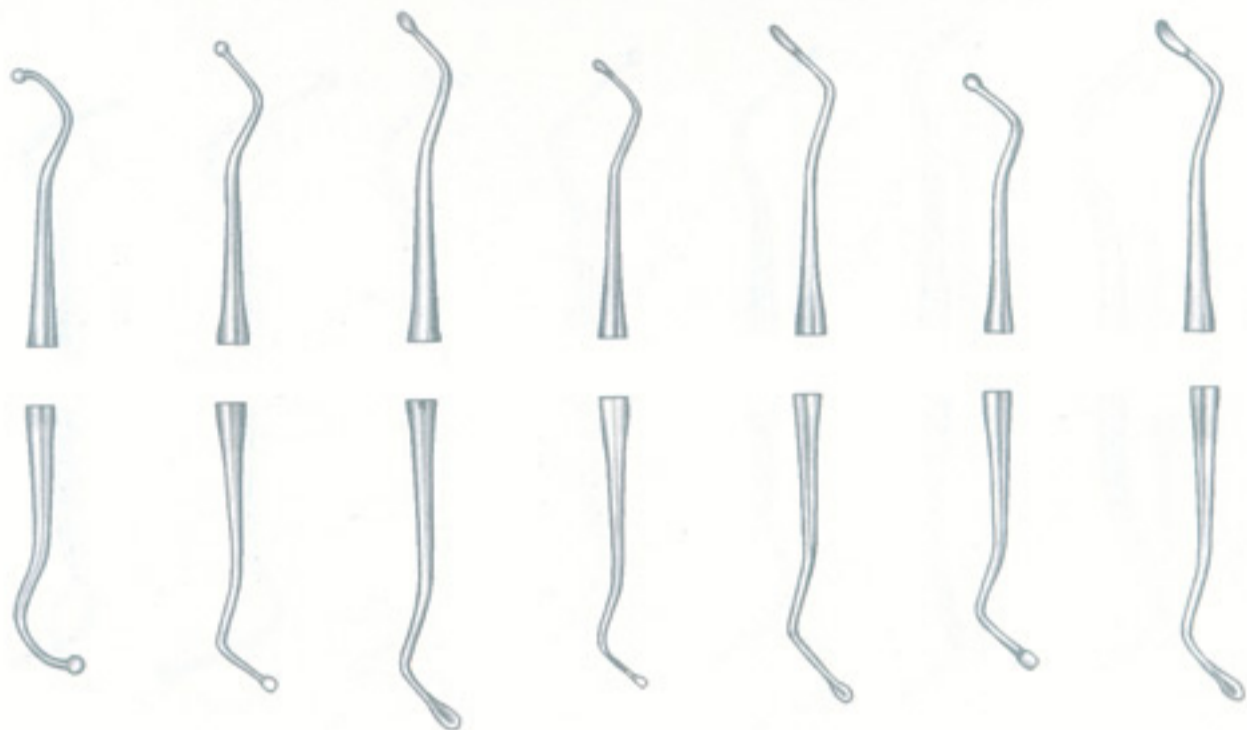

786-807
Fig. 14

786-808
Fig. 17

786-809
Fig. 17 W
Oval spoon

786-810
Fig. 18

786-811
Fig. 18 W
Oval spoon

786-812
Fig. 19

786-813
Fig. 19 W
Oval spoon

786-025-175 Set of 5

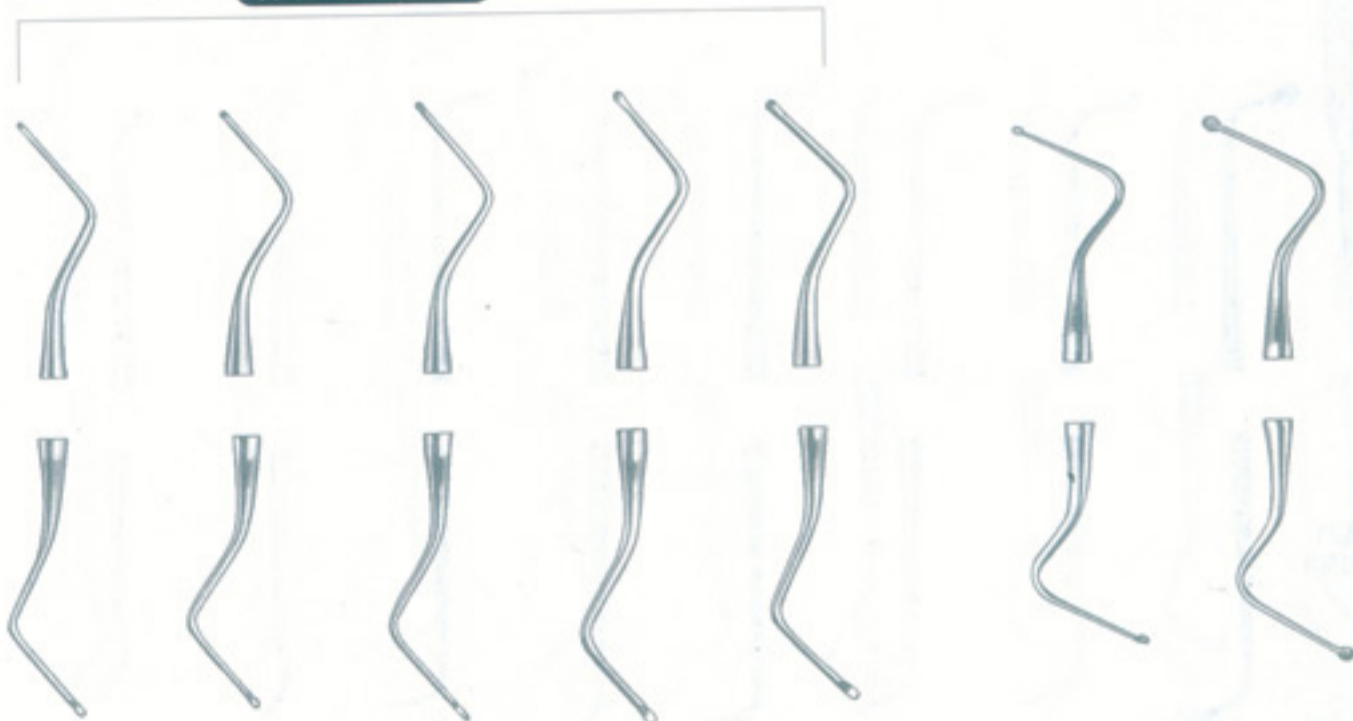

786-814
Fig. 0

786-815
Fig. 1

786-816
Fig. 2

786-817
Fig. 3

786-818
Fig. 4

786-819
Fig. 1

786-820
Fig. 2



SALIM
Group Of Industries

EXCAVATORS



786-821
Fig. 38/39

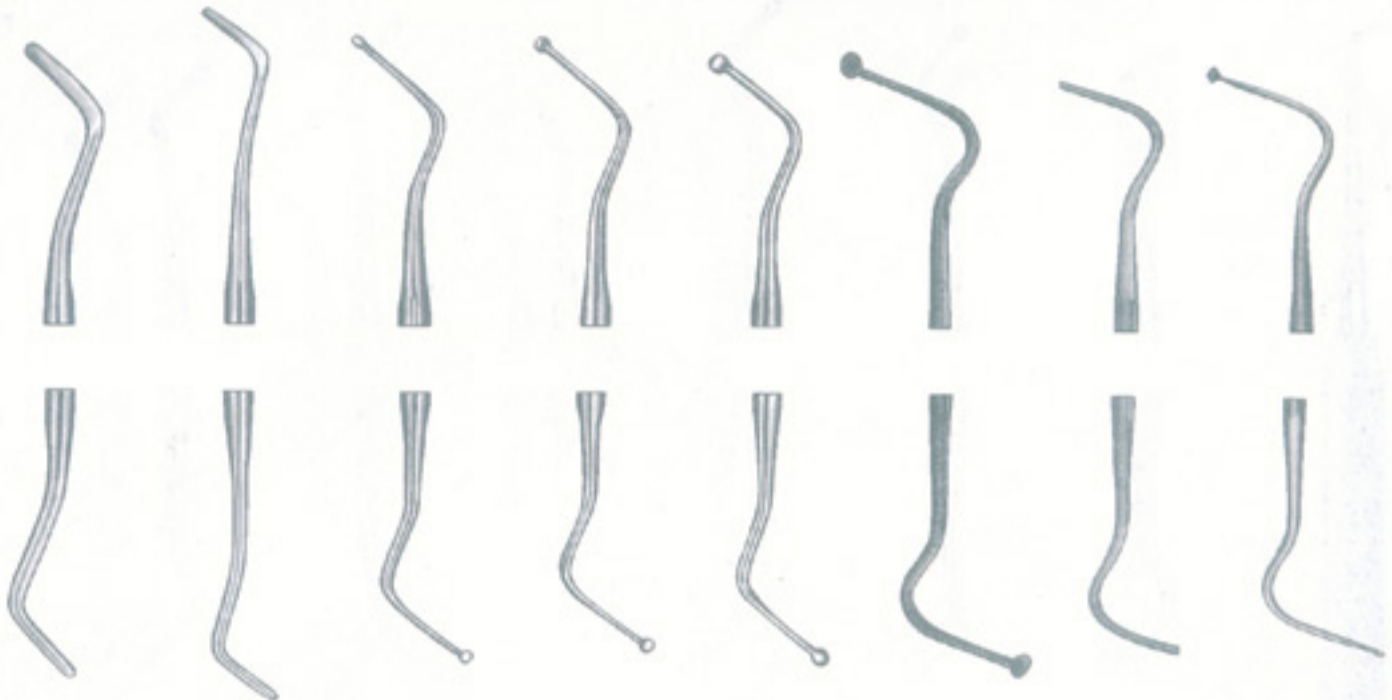

786-822
Fig. 63/64

786-823
Fig. 65/66

786-824
Fig.31L

786-825
Fig.32L

786-826
Fig.33L

786-827
Fig.135/136

786-828
Fig.139/140

786-829
Fig.141/142

root canal excavators

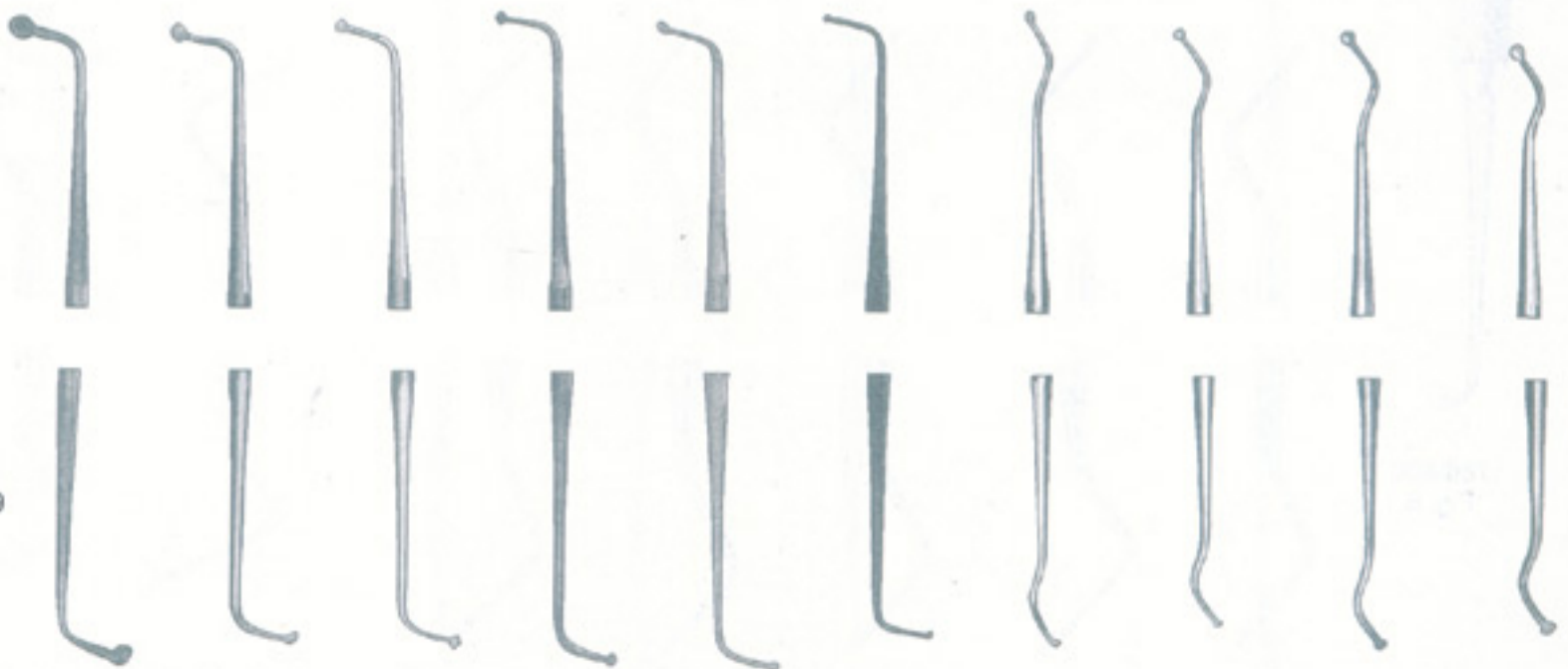

786-830
Fig.113/114

786-831
Fig.115/116

786-832
Fig.117/118

786-833
Fig.119/120

786-834
Fig.121/122

786-835
Fig.123/124

786-836
Fig.153/154

786-837
Fig.155/156

786-838
Fig.157/158

786-839
Fig.159/160

EXCAVATORS ENGLISH PATTERN

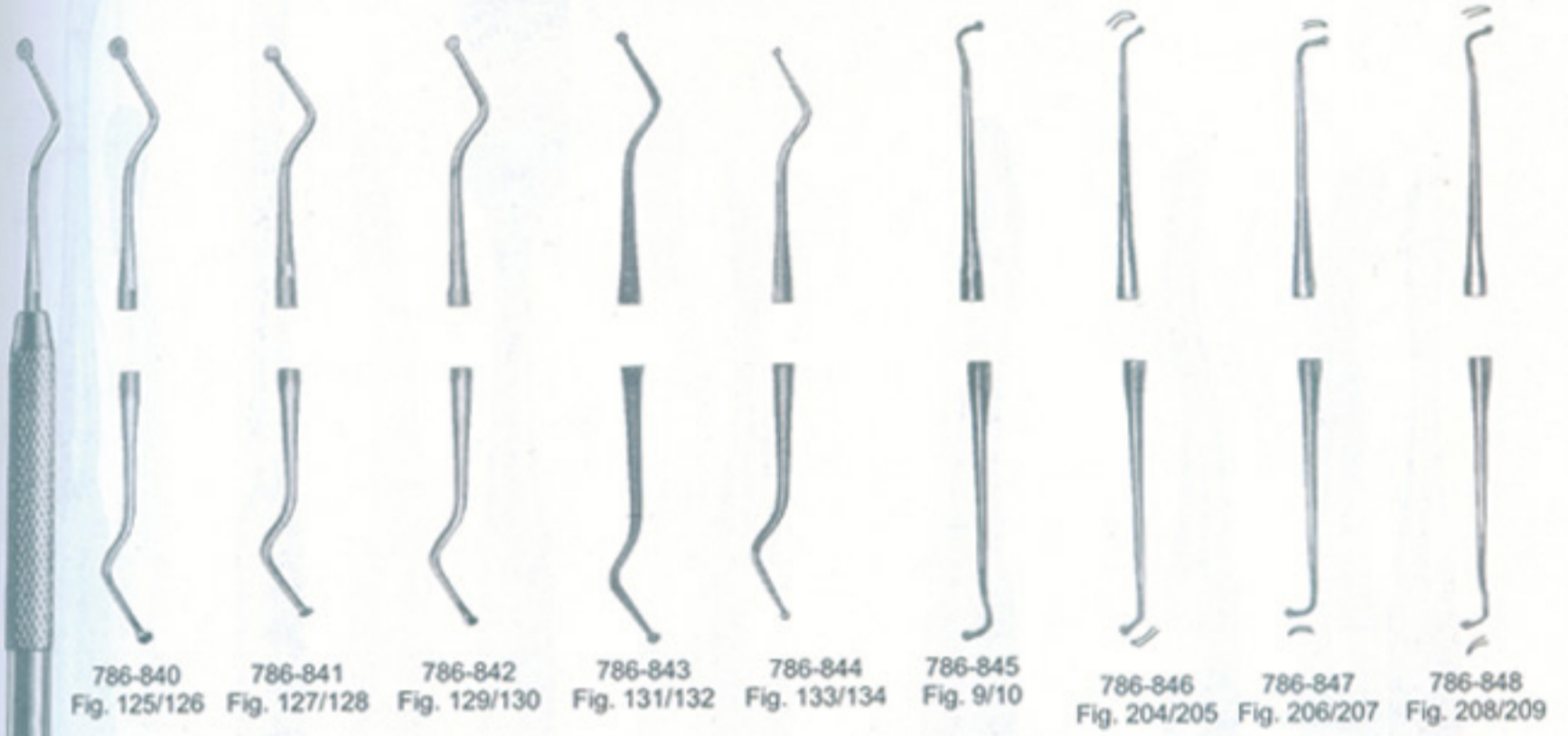

786-840
Fig. 125/126

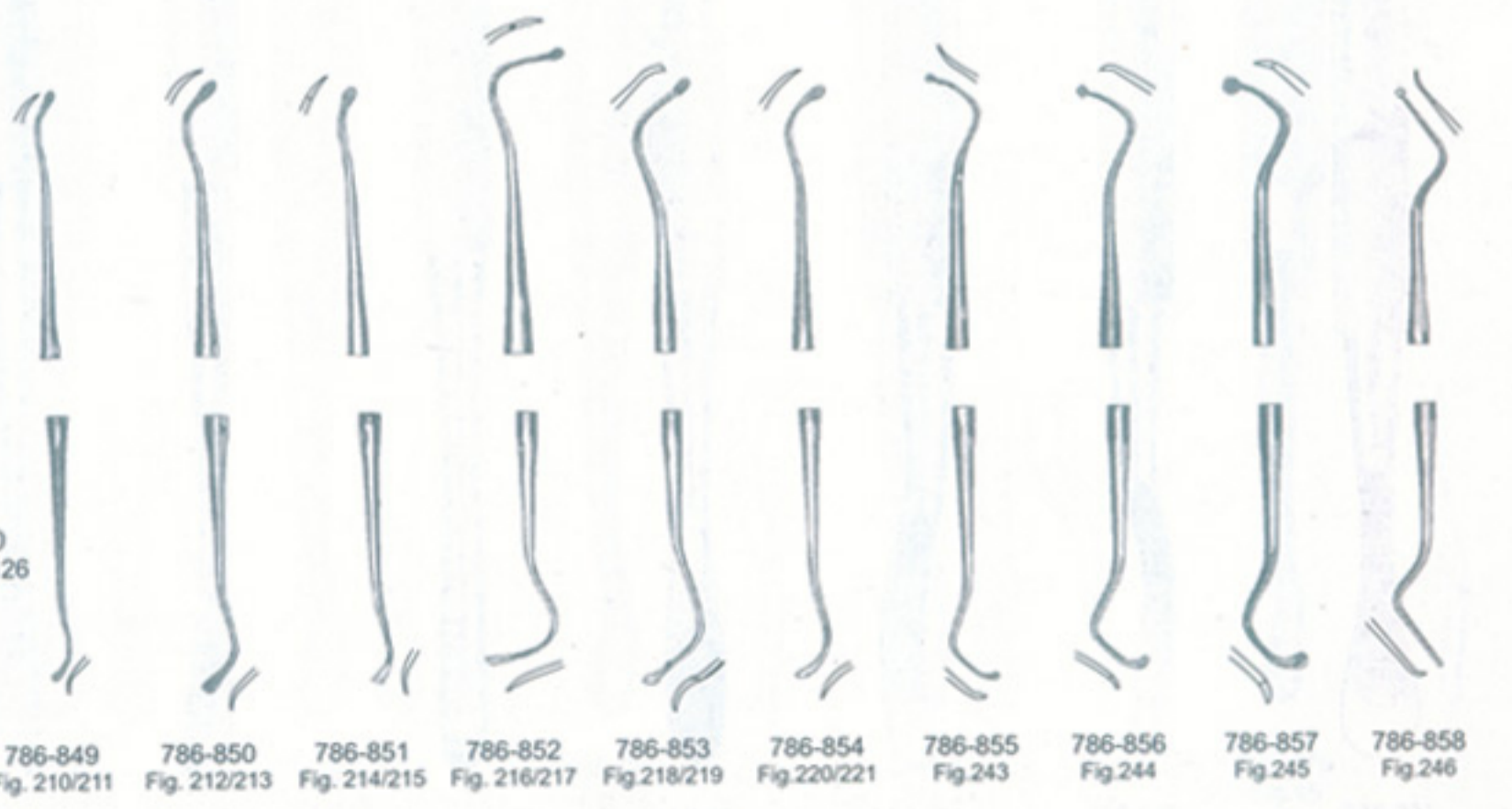



SALIM
Group Of Industries

PERIODONTIA INSTRUMENTS



786-859
Fig. M9
Molt

786-860
Fig.1
Hopkins

786-861
Fig.2
Hopkins

786-862
Fig.3
Mead

786-863
Fig. PR3
Prichard

786-864
Fig.15
Freer

786-3865
Fig.16
Freer

FILLING INSTRUMENTS PLASTIC FILLING INSTRUMENTS

SALIM
Group Of Industries



786-866
Fig.12 CA

786-867
Fig.12 A

786-868
Fig.12
Howard

786-869
Fig.33

786-870
Fig.45
Miller



SALIM
Group Of Industries

Bone Files



786-871
Fig.1
Wahl



786-872
Fig.2
Wahl

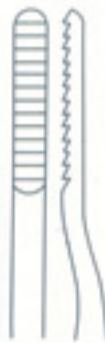

786-873
Fig.1
Polokoff



786-874
Fig.64
Miller

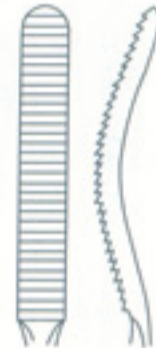

786-875
Fig.10

BONE CURETTES PERIODONTIA INSTRUMENTS

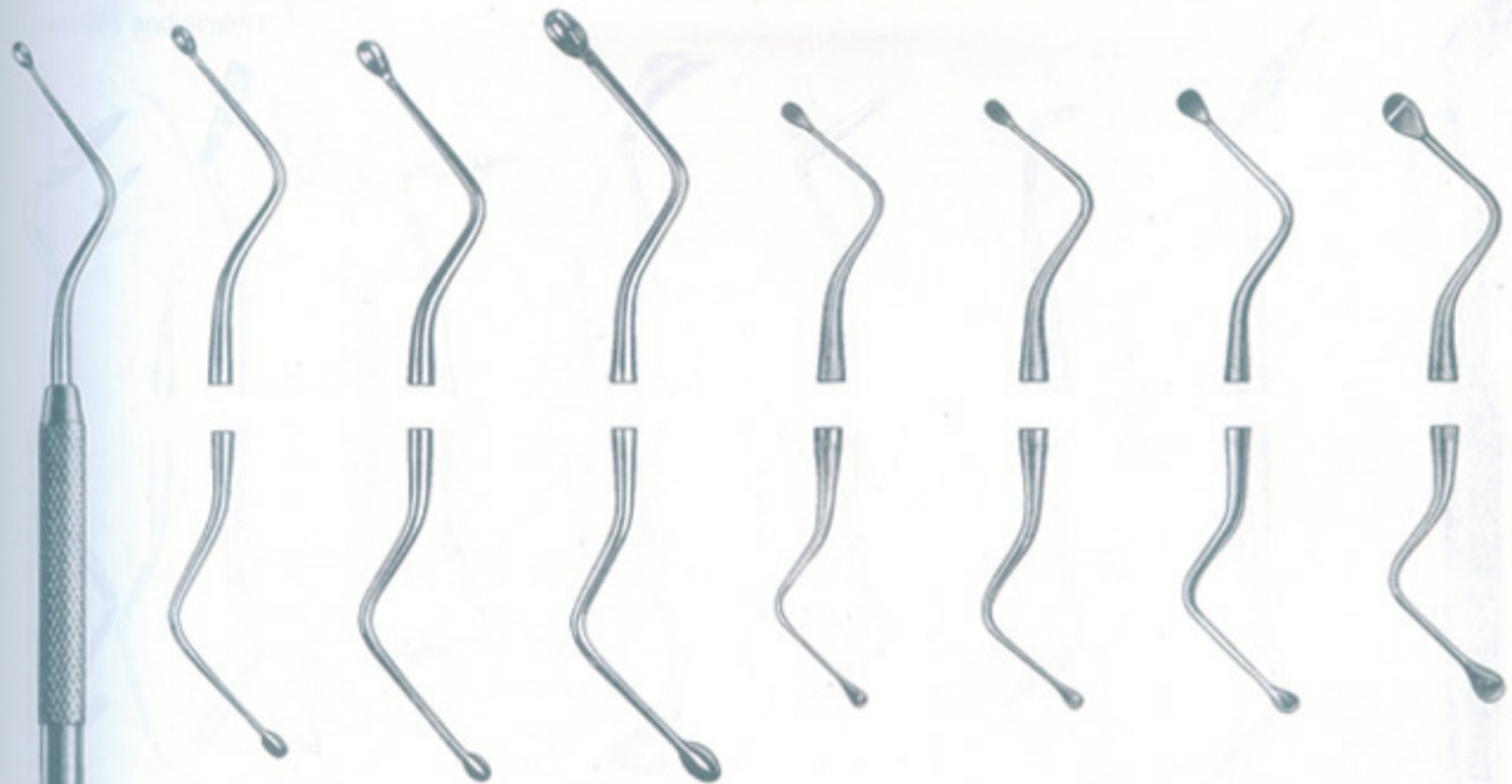

786-877
Fig.2
Hemingway

786-878
Fig.3
Hemingway

786-879
Fig.4
Hemingway

786-880
Fig.85
Lucas

786-881
Fig.86
Lucas

786-882
Fig.87
Lucas

786-883
Fig.88
Lucas

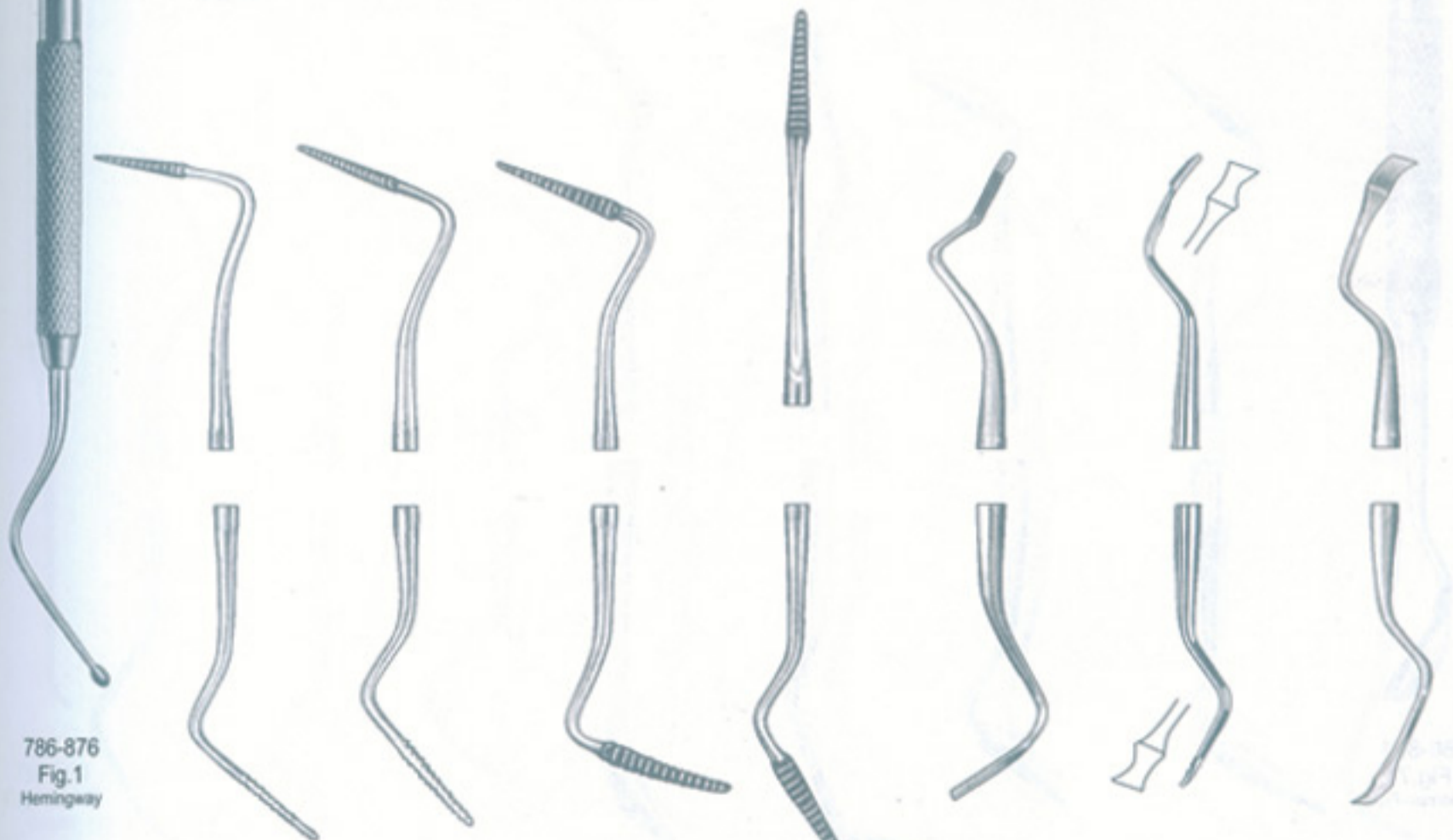

786-876
Fig.1
Hemingway

786-884
Fig.1S/2S
Sugarman

786-885
Fig.3S/4S
Sugarman

786-886
Fig.9/10
Schluger

786-887
Fig.11/12
Buck

786-888
Fig.3
Ochsenbein

786-889
Fig.4
Ochsenbein

786-890
Fig.36/37
Rhodes Back-Action



SALIM
Group Of Industries

PERIODONTIA INSTRUMENTS



786-891
Fig.7
Goldman-Fox



786-892
Fig.8
Goldman-Fox



786-893
Fig.9
Goldman-Fox



786-894
Fig.11
Goldman-Fox



786-895
Fig.3/4
Buck



786-896
Fig.5/6
Buck



786-897
Fig.1/2
(15k/16k)
Kirkland



786-898
Fig.1/2
Orabn



786-899
Fig.1/2
Sanders

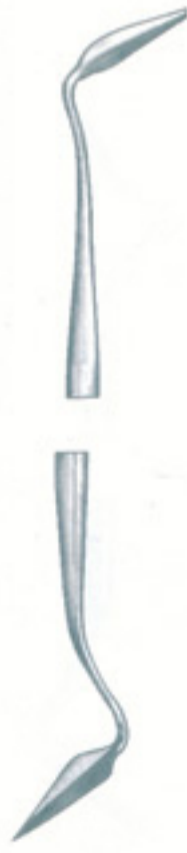

786-900
Fig.4/5
Sanders

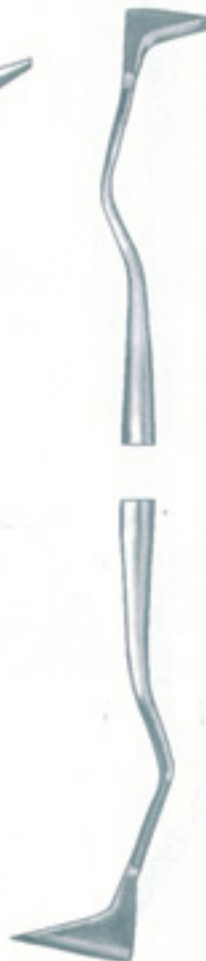

786-901
Fig.19/20
(University of South California)
USC Towner



786-902
Fig.CK3
Crane-Kaplan

PERIODONTIA INSTRUMENTS

curettes and scalers

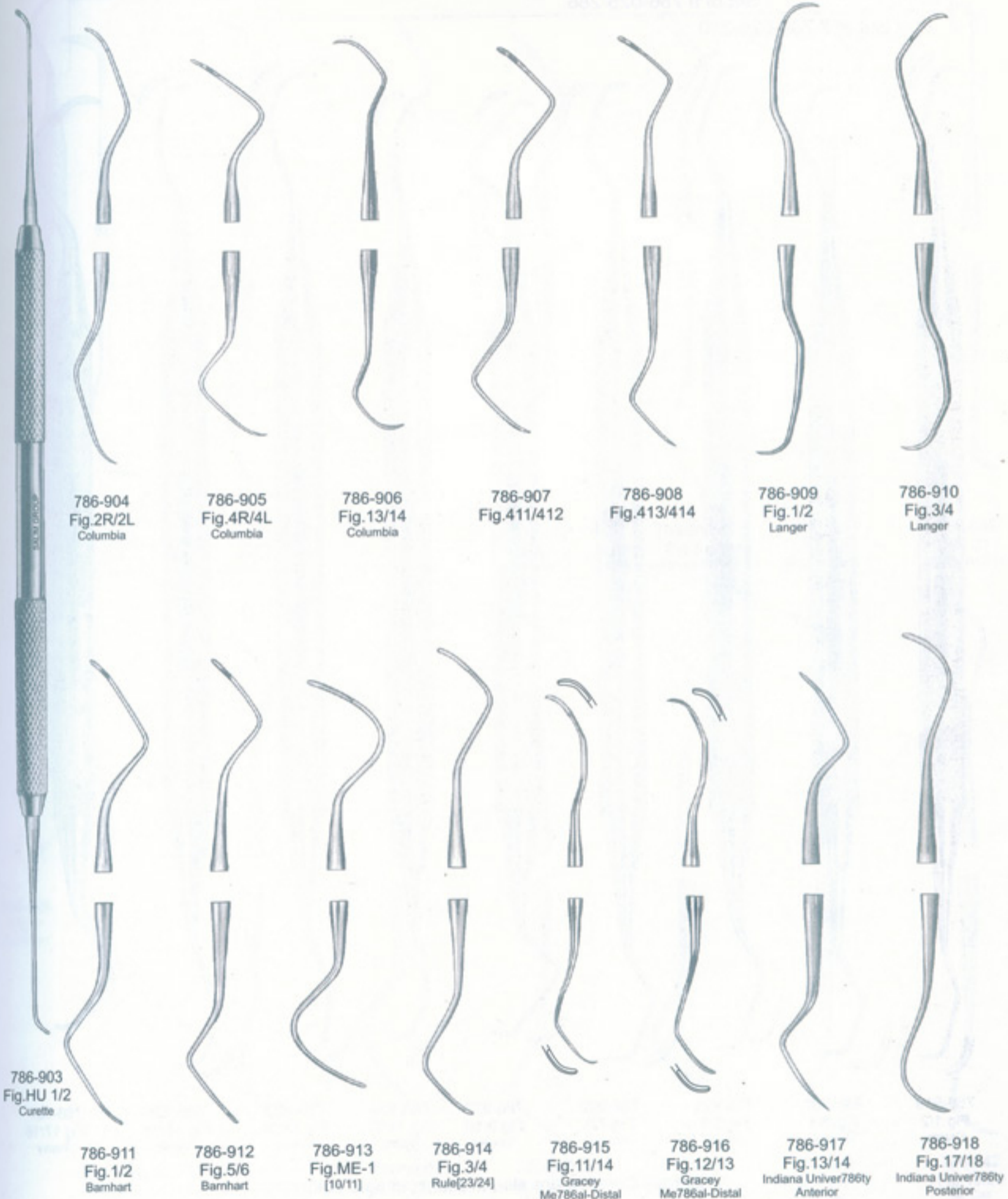



SALIM
Group Of Industries

PERIODONTIA INSTRUMENTS GRACEY CURETTES

Set of 9 786-025-286

Set of 7 786-025-280

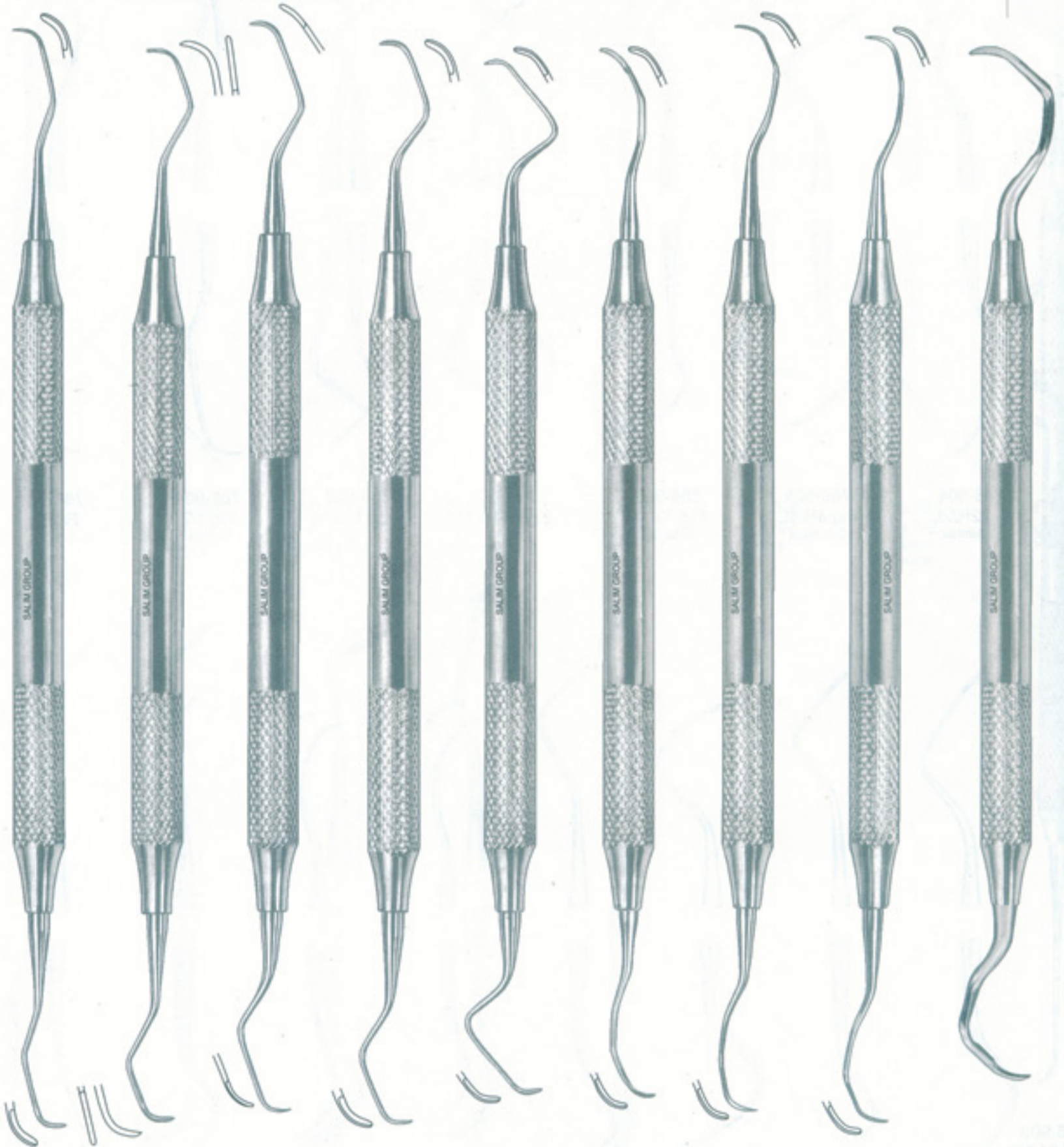

786-919
Fig.1/2
Gracey

786-920
Fig.3/4
Gracey

786-921
Fig.5/6
Gracey

786-922
Fig.7/8
Gracey

786-923
Fig.9/10
Gracey

786-924
Fig.11/12
Gracey

786-925
Fig.13/14
Gracey

786-926
Fig.15/16
Gracey

786-927
Fig.17/18
Gracey

Gracey Curettes are also available in rigid points

PERIODONTIA INSTRUMENTS

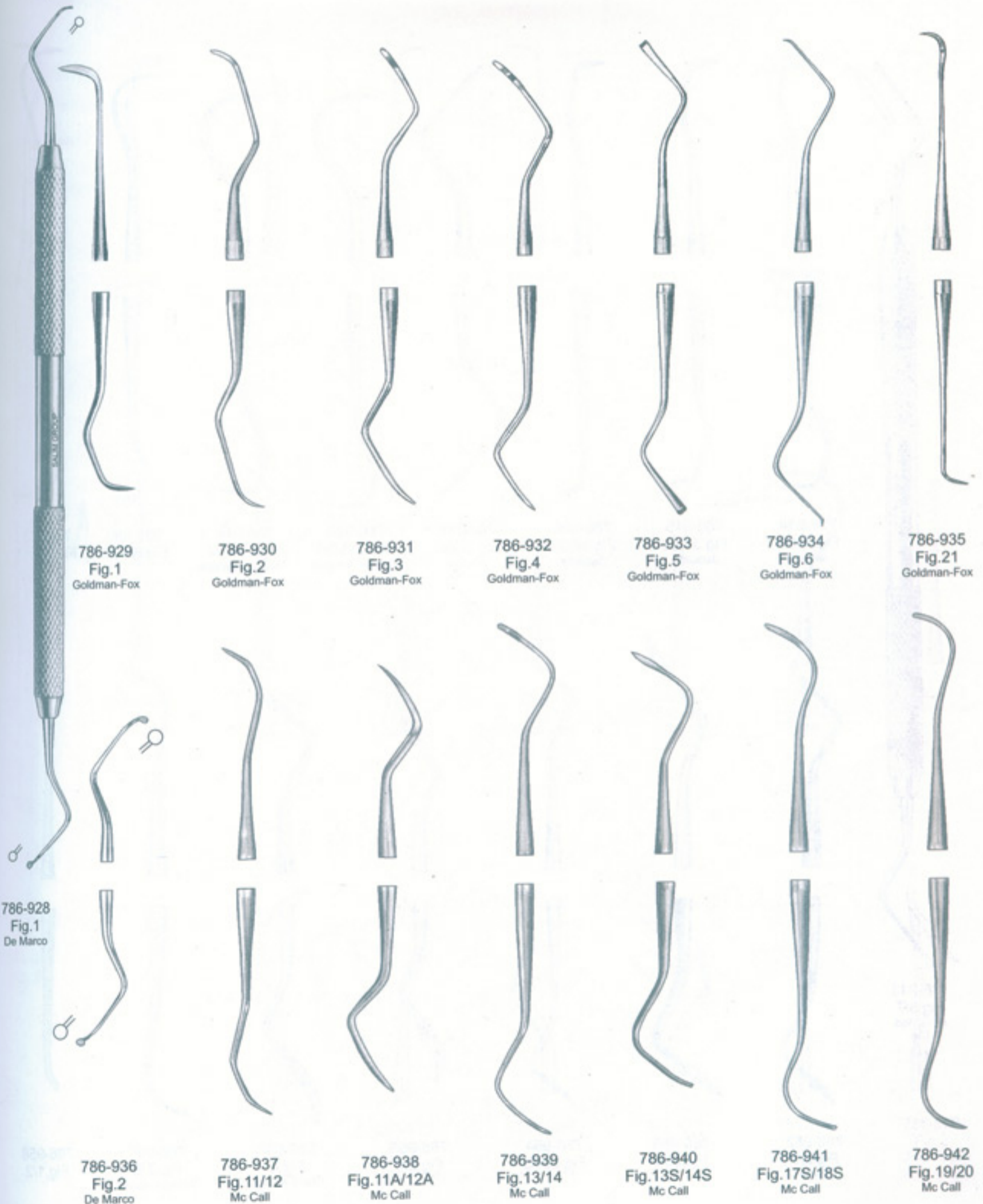



SALIM
Group Of Industries

PERIODONTIA INSTRUMENTS SCALERS

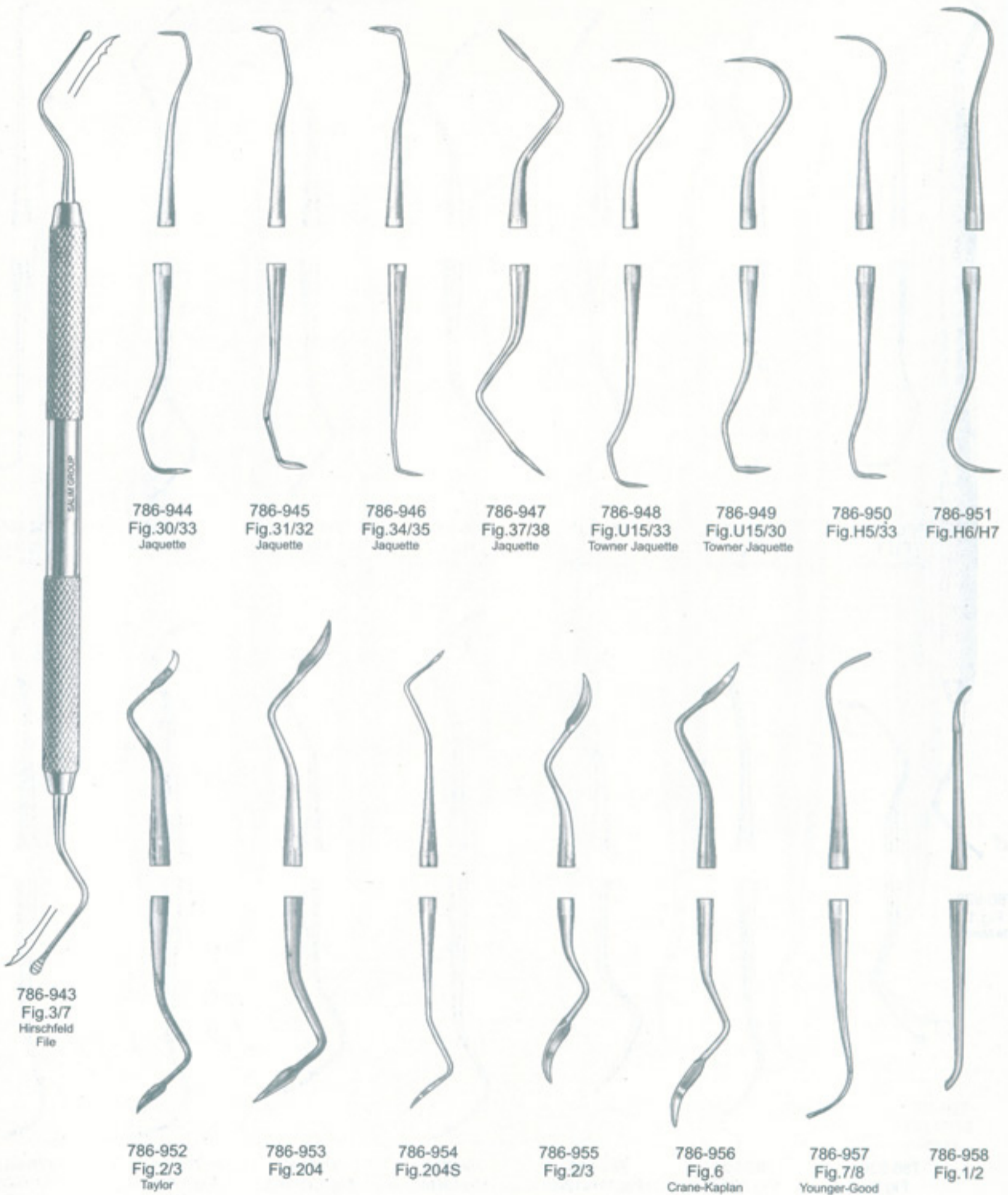

PERIODONTIA INSTRUMENTS
SCALERS





SALIM
Group Of Industries

CEMENT SPATULAS HEIDEMANN SEPARATING SPATULAS



WAX AND MODELLING CARVERS

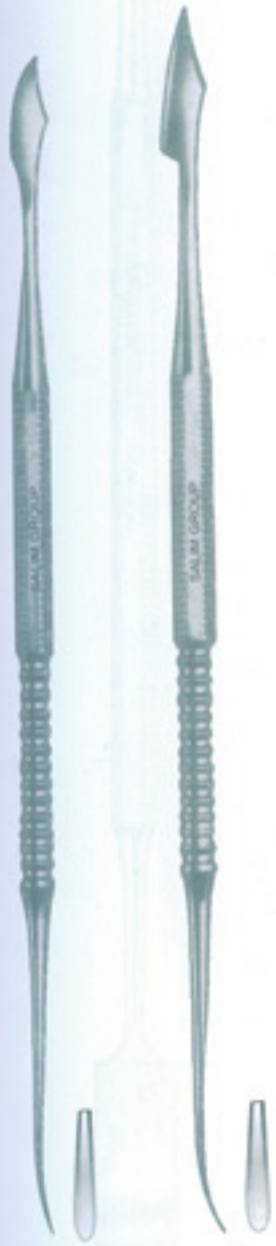

786-991
Zahle

786-992
Zahle



786-993
Zahle



786-994
Hylin



786-995
Hylin-Ceramica



786-996
Hylin-Sacred



786-997
Hylin-Le Cron



786-998
Sacred



SALIM
Group Of Industries

WAX AND MODELLING CARVERS



786-999
Le Cron

786-1000
Le Cron

786-1001
Vehe

786-1002
Beale

786-1003
Roach

786-1004
Le Cron

786-1005
Le Cron

786-1006
Gritman

SP WAX AND MODELLING CARVERS



786-1007
Fig.1
P.K. Thomas



786-1008
Fig.2
P.K. Thomas



786-1009
Fig.3
P.K. Thomas



786-1010
Fig.4
P.K. Thomas



786-1011
Fig.5
P.K. Thomas



SALIM
Group Of Industries

WAX KNIVES



786-1012
Fig.1
Fahnenstock
cm. 12,5



786-1013
Fig.1
Lessmann
cm. 12,5



786-1014
Fig.1
Con Scodellino
cm. 12,5



786-1015
Fig.2
Fahnenstock
cm. 17



786-1016
Fig.2
Lessmann
cm. 17



786-1017
Fig.2
Con Scodellino
cm. 17

SPATULAS FOR PLASTER AND ALGINATE

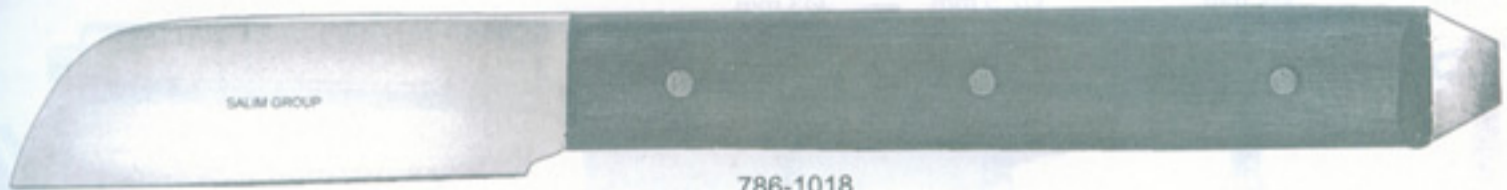

786-1018
cm. 17



786-1019
cm. 17 Gritman



786-1020
cm. 19,5

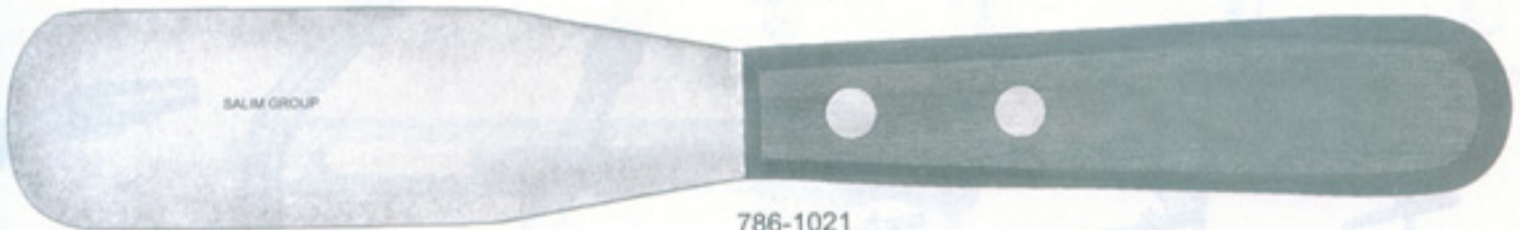

786-1021
cm. 21,5



786-1022
cm. 20,5



786-1023
cm. 19,5



786-1024
cm. 20



786-1025
cm. 22,5



SALIM
Group Of Industries

AMALGAM CARRIERS

Ø1,5 mm



786-1026
Small

Ø2 mm



786-1027
Medium

Ø2,5 mm



786-1028
Large

Ø3 mm



786-1029
Jumbo



786-1030
Amalgam well

Ø2 mm



786-1031
Medium /Small

Ø2 mm



786-1032
Medium /Large

Ø2 mm



786-1033
Medium /Jumbo



786-1034

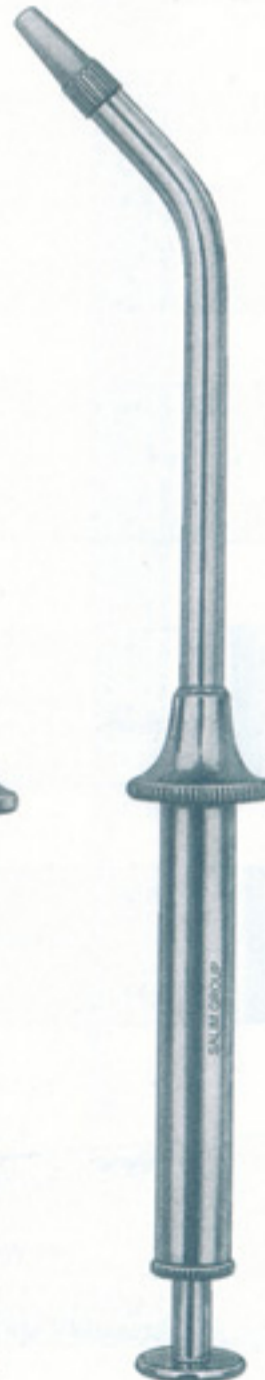

786-1035

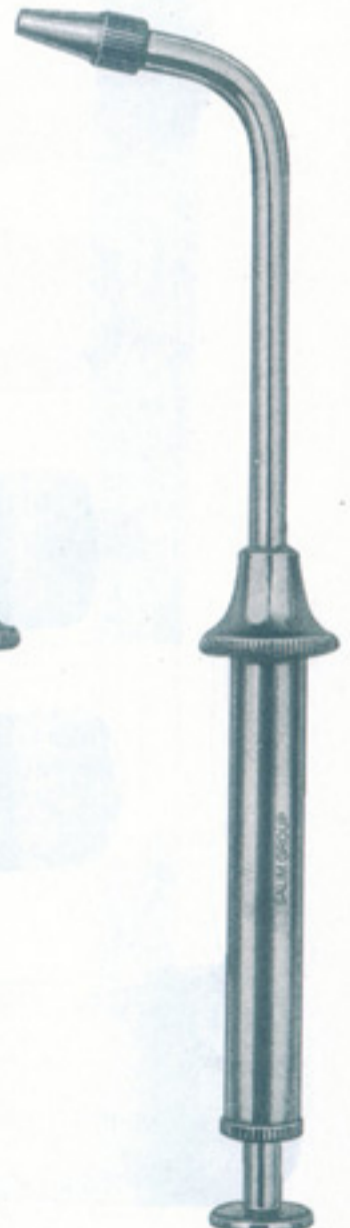

786-1036

DENTAL CARTRIDGE SYRINGES

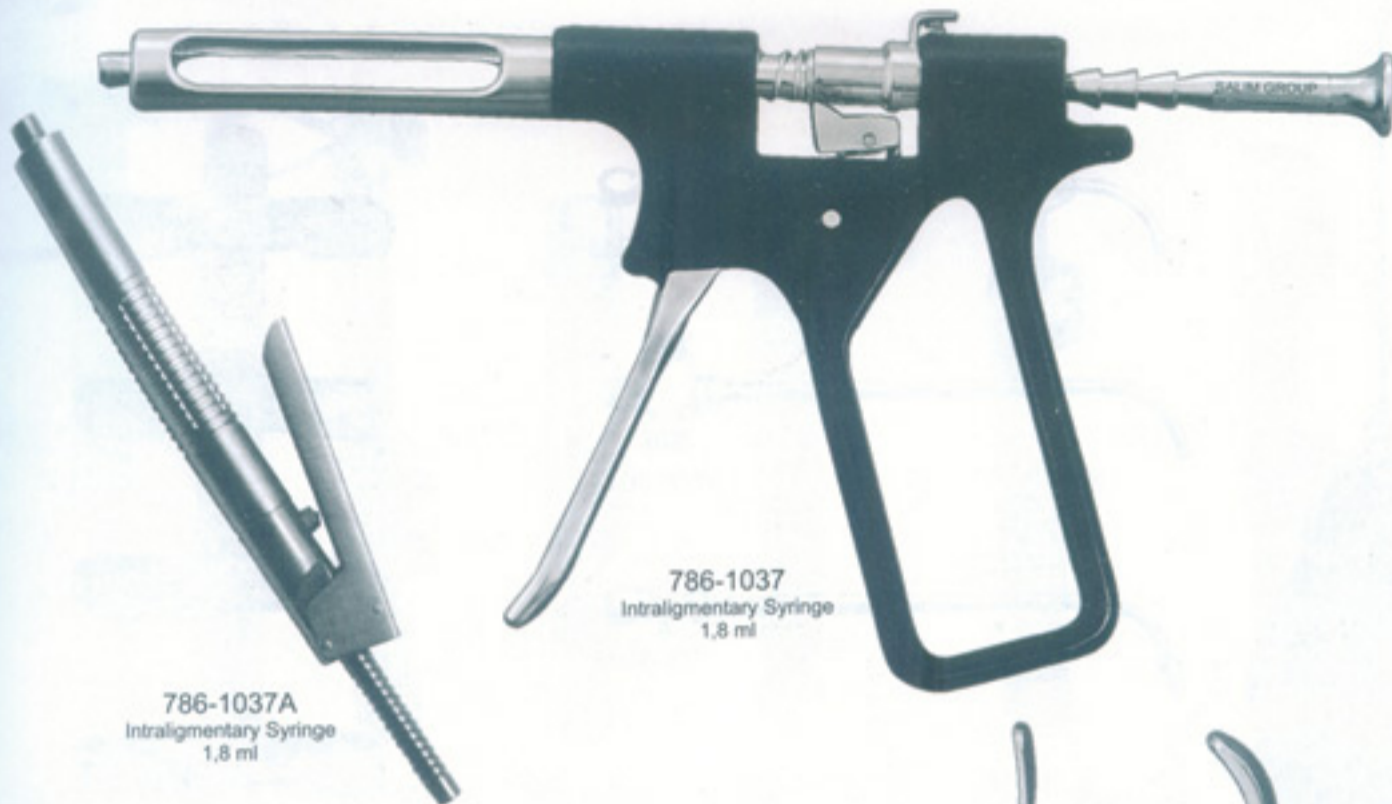

786-1037
Intraligmentary Syringe
1,8 ml

786-1037A
Intraligmentary Syringe
1,8 ml

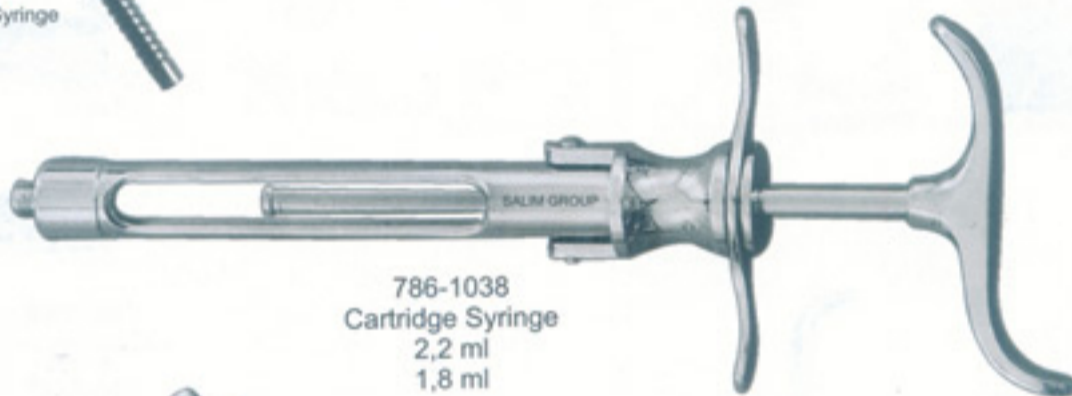

786-1038
Cartridge Syringe
2,2 ml
1,8 ml

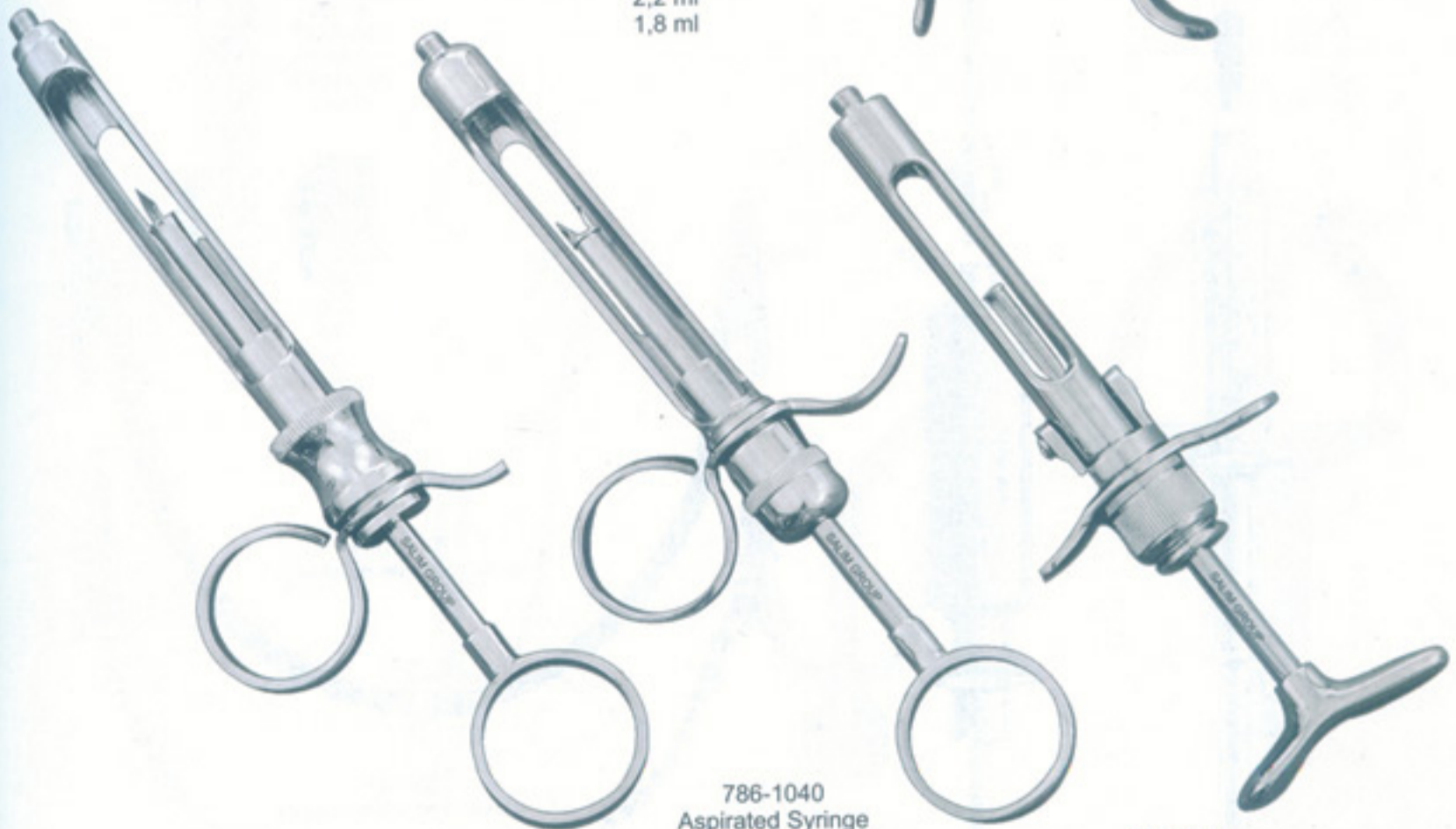

786-1039
Aspirated Syringe
1,8 ml

786-1040
Aspirated Syringe
1,8 ml

786-1041
Cartridge Syringe
1,8 ml

Available Thread:- Inches & Metric



SALIM
Group Of Industries

CHIP BLOWERS, WATER SYRINGES
NAPKIN HOLDER, FILM HOLDER



786-1042
Chip Blower

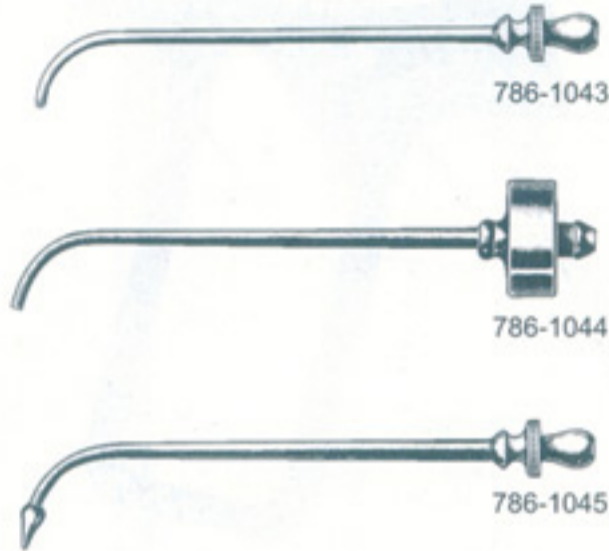

786-1043

786-1044

786-1045

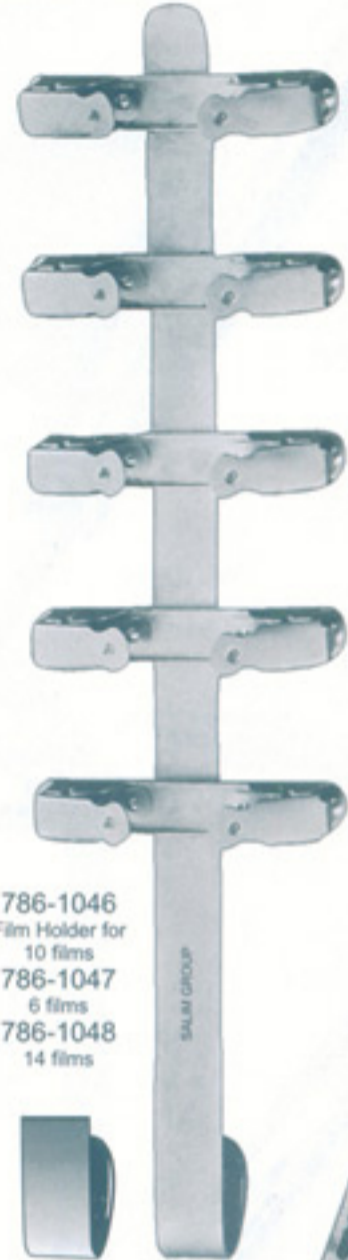

786-1046
Film Holder for
10 films
786-1047
6 films
786-1048
14 films



786-1049
Water Syringe



786-1050
Water Syringe

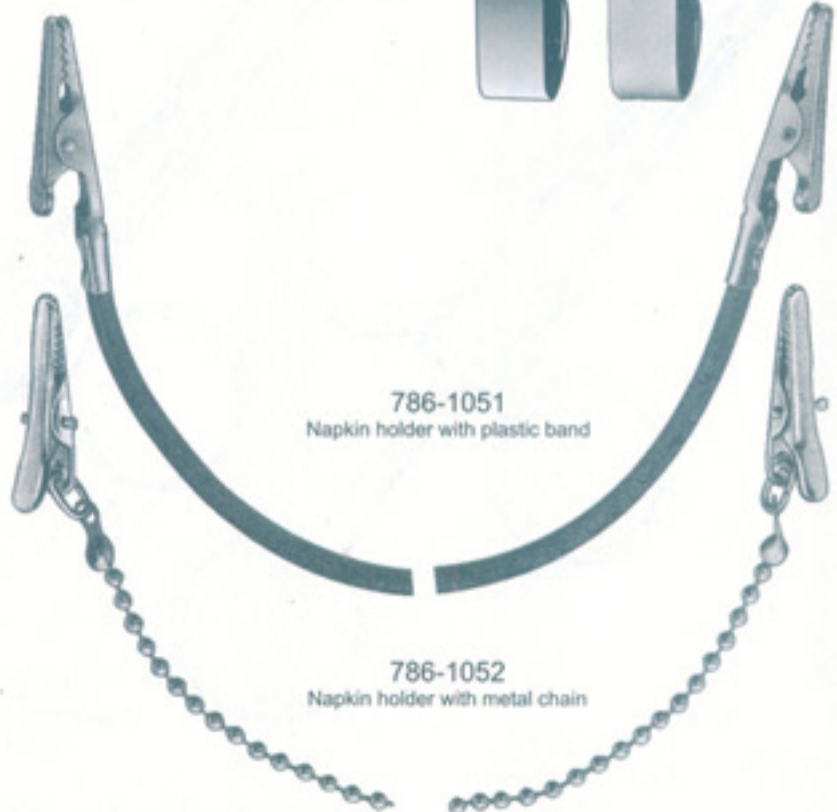

786-1051
Napkin holder with plastic band

786-1052
Napkin holder with metal chain

MATRIX RETAINERS



786-1053 - 5mm
786-1054 - 6mm
786-1055 - 7mm
Ivory 8



786-1056
Ivory 8 N



786-1057
Ivory 8



786-1058
786-1059
786-1058-786-1059
Ivory 8



786-1060
Fig. 1
Tofflemire-Universal



786-1061
Fig. 3
Tofflemire-Senior



786-1062
Fig. 2
Tofflemire-junior



Adjustable

786-1063
Fig. 2
Didner 8P



786-1064
Ivory



With lateral shields

786-1065
Ivory



786-1066
Ivory
Separator



SALIM
Group Of Industries

CROWN INSTRUMENTS

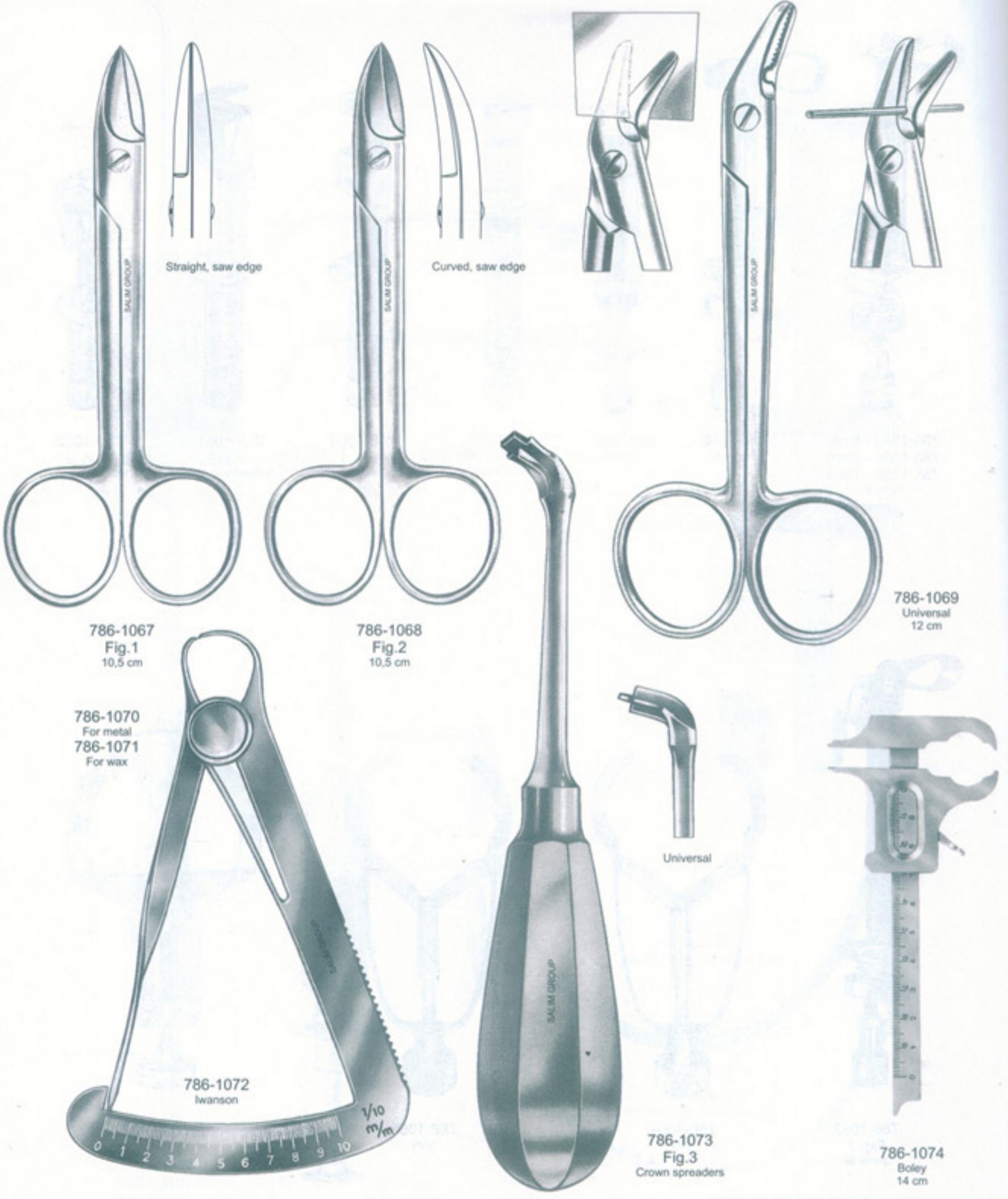

Straight, saw edge

Curved, saw edge

786-1067
Fig.1
10,5 cm

786-1068
Fig.2
10,5 cm

786-1069
Universal
12 cm

786-1070
For metal
786-1071
For wax

Universal

786-1072
Iwanson

786-1073
Fig.3
Crown spreaders

786-1074
Boley
14 cm

CROWN REMOVERS



786-1076
Crown removers



1



2



3



786-1075
Crown removers
Automatic



1



2



3



786-1077
Crown removers



1



2



3

with 5 Points



4



5



786-1078
Crown removers



1



2



3



4



SALIM
Group Of Industries

CROWN INSTRUMENTS PLASTER CUTTING PLIER



786-1079
15 cm

Articulating
paper forceps



786-1080
Miller
15 cm

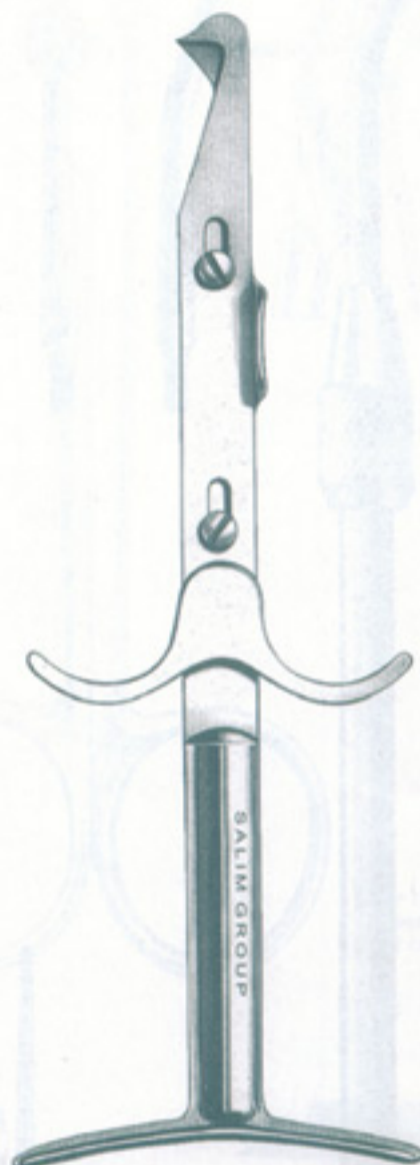

786-1081
Crown Spreader

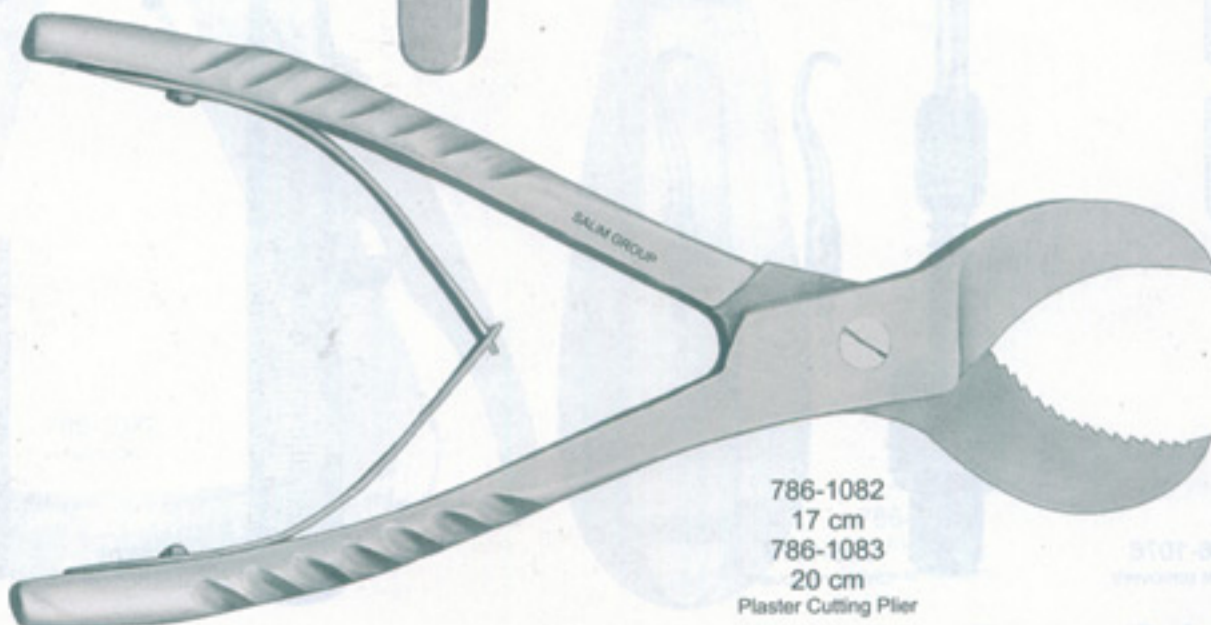

786-1082
17 cm
786-1083
20 cm
Plaster Cutting Plier

STAINLESS STEEL IMPRESSION TRAYS MADE OF 18/8 STAINLESS STEEL

Solid Partial Set of 10
786-225-001

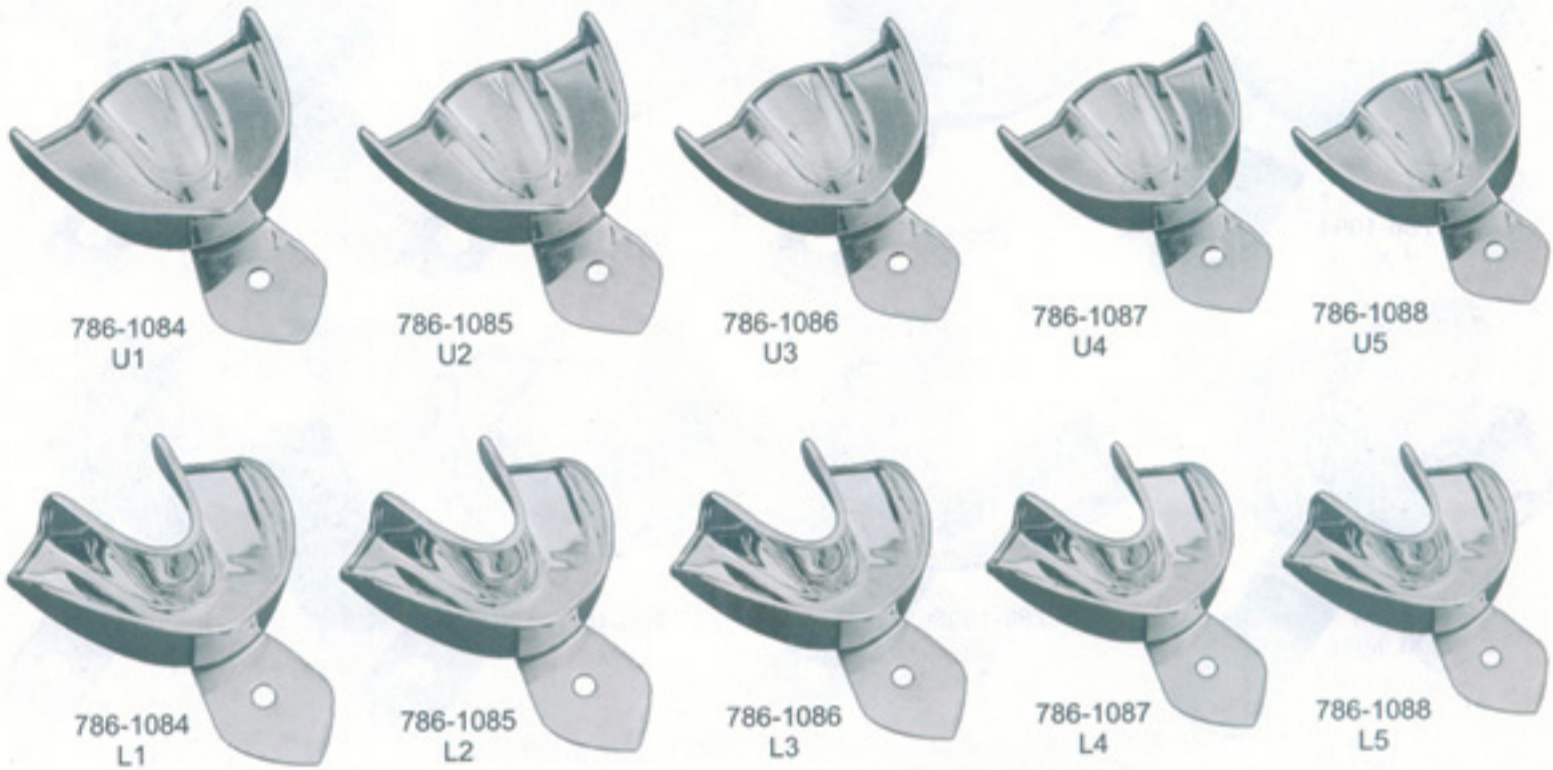

All the above impression trays are available in these 5 sizes

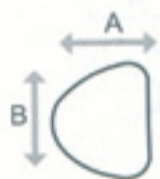

UPPER		U1	U2	U3	U4	U5
	A	62	60	53	54	52
B	83	75	73	69	68	

All Dimensions are in mm

LOWER		L1	L2	L3	L4	L5
	A	63	61	57	60	53
B	82	81	78	74	71	

All Dimensions are in mm

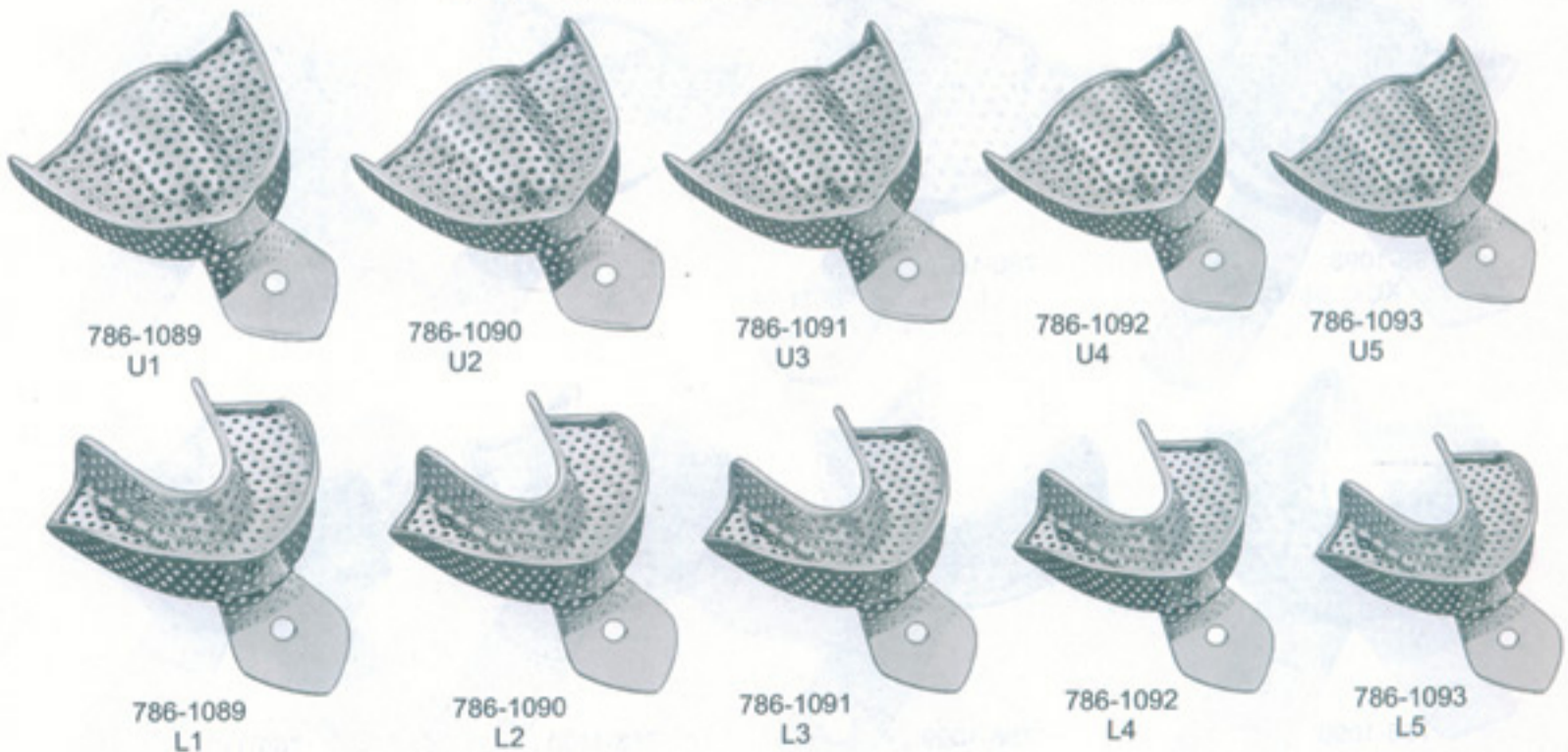

Perforated Partial Set of 10
786-225-010



SALIM
Group Of Industries

**STAINLESS STEEL IMPRESSION TRAYS
MADE OF 18/8 STAINLESS STEEL**

Solid Full Denture Set of 8
786-225-011



786-1094
XL



786-1095
L



786-1096
M



786-1097
S



786-1094
XL



786-1095
L



786-1096
M

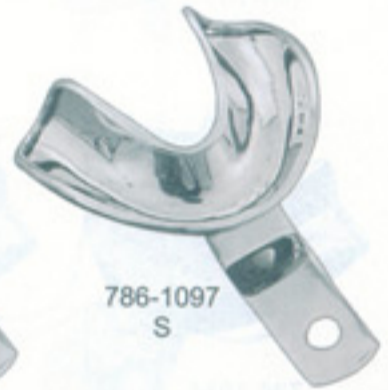

786-1097
S

All the above impres786on trays are available in these 4 786zes



UPPER		XL	L	M	S
	A	70	67	64	60
B	79	76	70	73	

All Dimen786on are in mm

LOWER		XL	L	M	S
	A	64	64	60	57
B	86	70	73	70	

All Dimen786on are in mm



786-1098
XL



786-1099
L



786-1100
M



786-1101
S



786-1098
XL



786-1099
L



786-1100
M



786-1101
S

Perforated Full Denture Set of 8
786-225-018

STAINLESS STEEL IMPRESSION TRAYS MADE OF 18/8 STAINLESS STEEL

Solid Set of 6
786-225-019



786-1102
U1



786-1103
U2



786-1104
U3



786-1102
L1



786-1103
L2



786-1104
L3

All the above impression trays are available in these 3 sizes



UPPER	All the above impression trays are available in these 3 sizes		
	U1	U2	U3
A	67	64	57
B	81	71	70

All Dimensions are in mm

LOWER	All the above impression trays are available in these 3 sizes		
	L1	L2	L3
A	60	57	54
B	81	79	76

All Dimensions are in mm

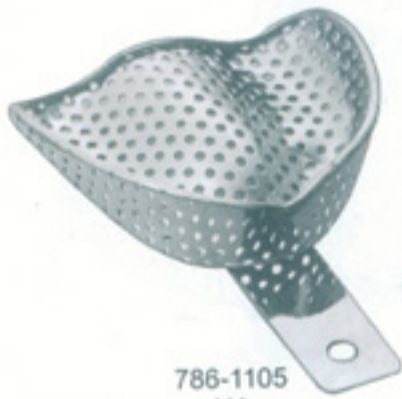

786-1105
U1



786-1106
U2



786-1107
U3



786-1105
L1



786-1106
L2



786-1107
L3

Perforated Set of 6
786-225-024



SALIM
Group Of Industries

STAINLESS STEEL IMPRESSION TRAYS MADE OF 18/8 STAINLESS STEEL

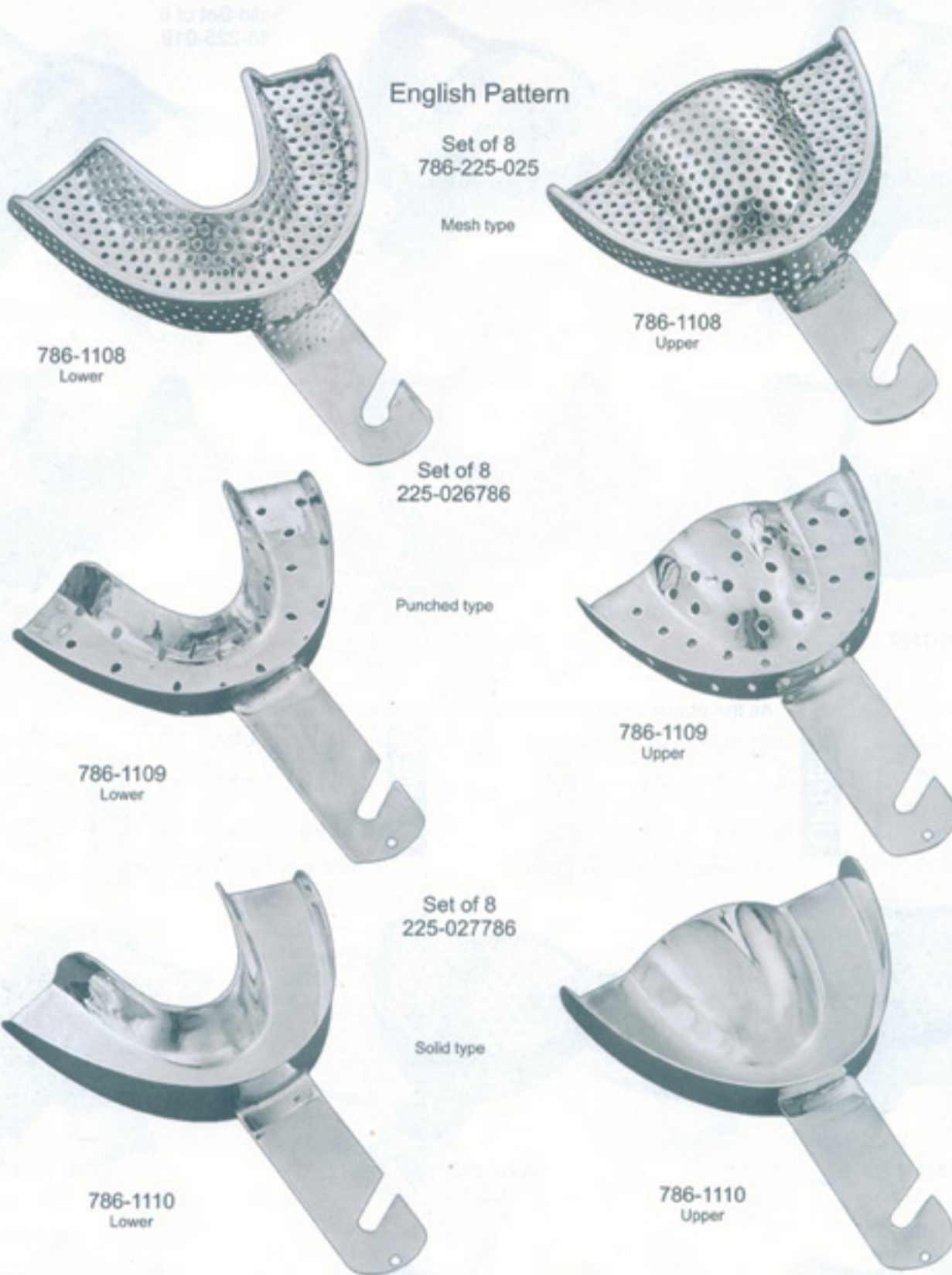

All the above impression trays are available in these 4 sizes



UPPER	786ze	A	B	C
	0	67	50	12
1	72	51	13	
2	78	55	15	
3	80	58	15	

All Dimensions are in mm

LOWER	786ze	A	B	C
	0	70	50	14
1	77	51	15	
2	79	55	15	
3	80	60	17	

All Dimensions are in mm



STAINLESS STEEL IMPRESSION TRAYS MADE OF 18/8 STAINLESS STEEL

Solid Full Denture Set of 8
786-225-028

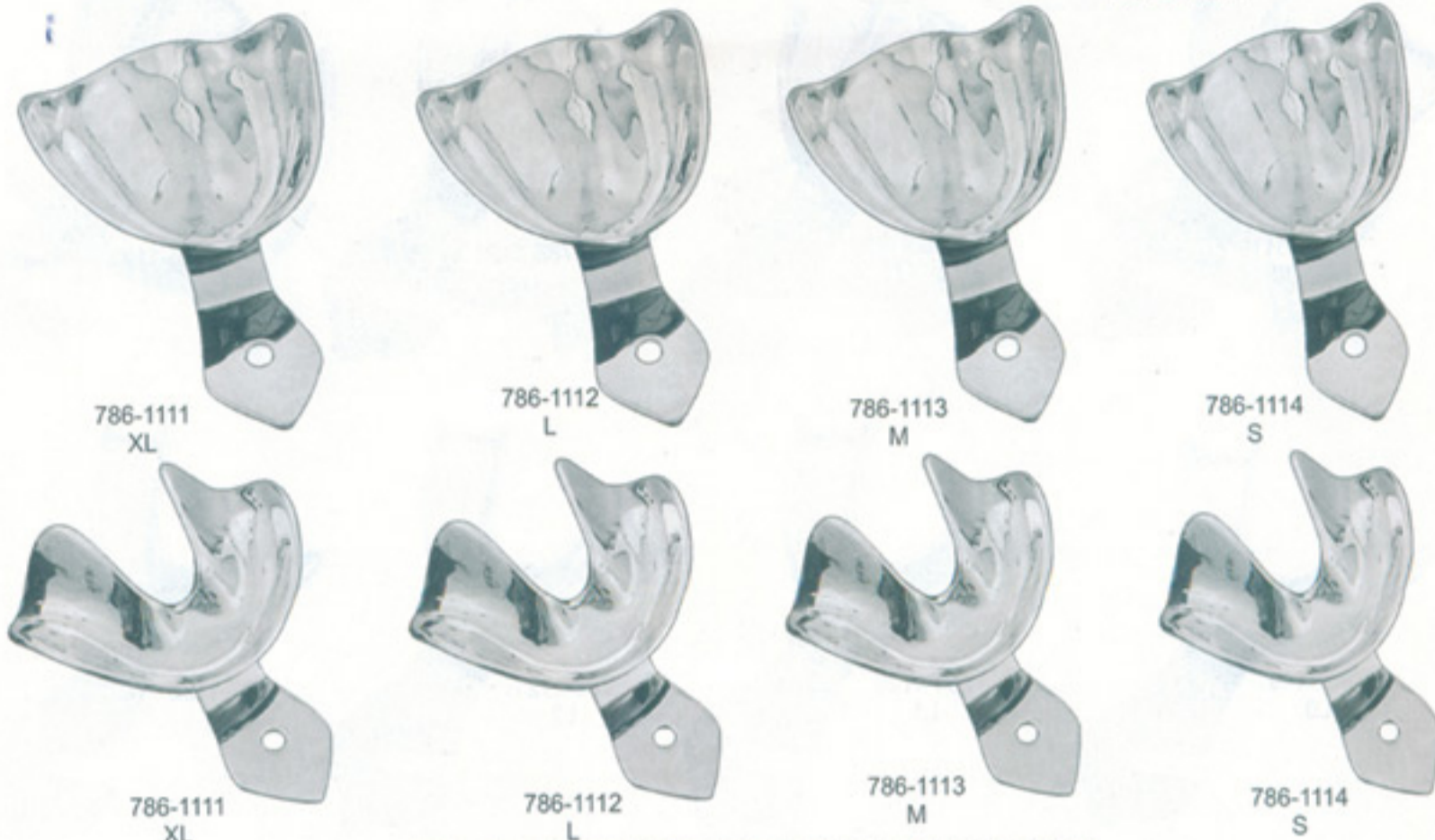

786-1111
XL

786-1112
L

786-1113
M

786-1114
S

786-1111
XL

786-1112
L

786-1113
M

786-1114
S

All the above impres786on trays are available in these 4 786zes

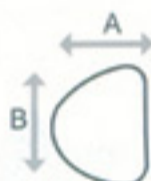

UPPER		XL	L	M	S
	A	70	67	64	60
B	79	76	70	73	

All Dimen786on are in mm

LOWER		XL	L	M	S
	A	64	64	60	57
B	86	70	73	70	

All Dimen786on are in mm

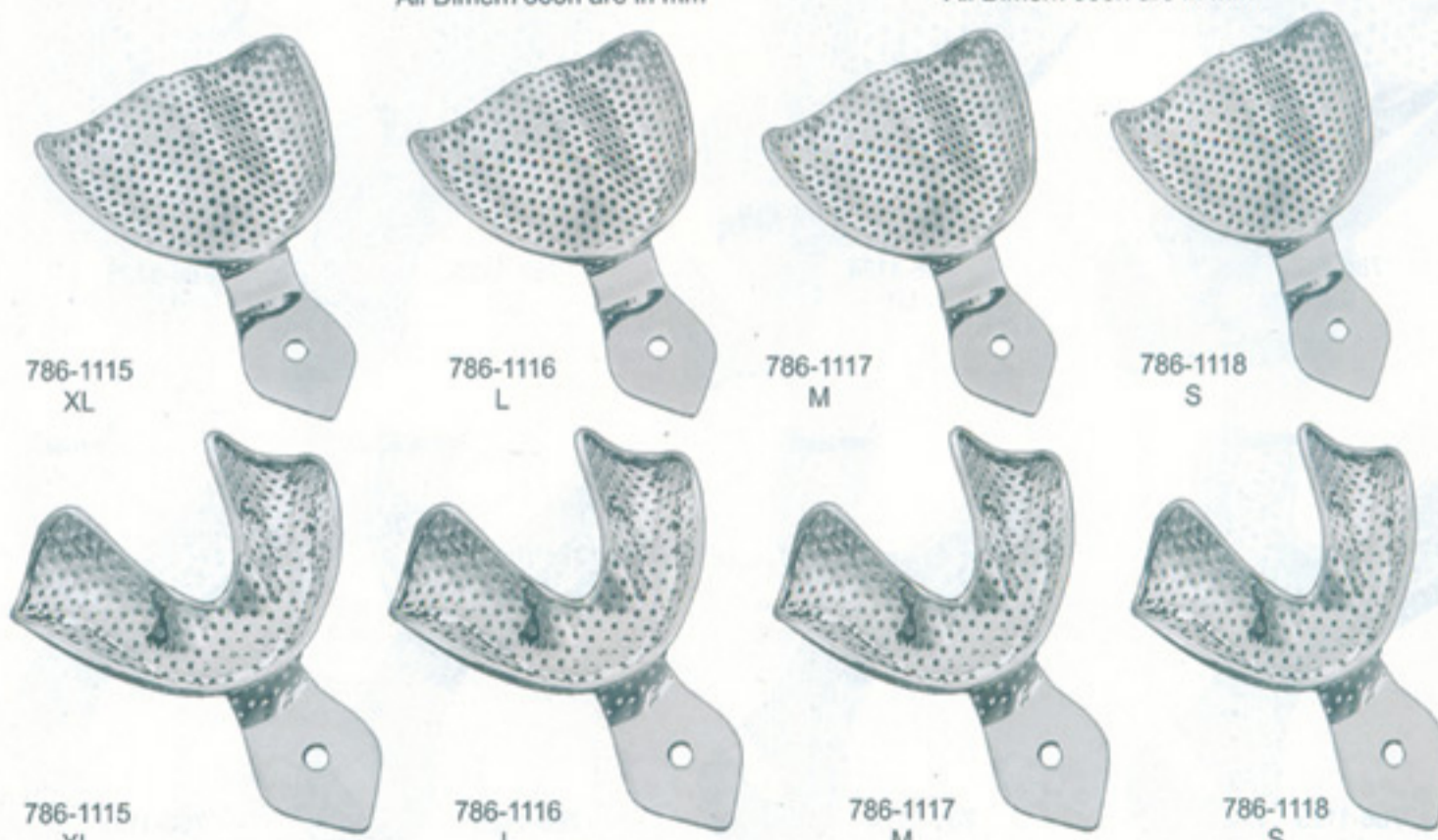

786-1115
XL

786-1116
L

786-1117
M

786-1118
S

786-1115
XL

786-1116
L

786-1117
M

786-1118
S

Perforated Full Denture Set of 8
786-225-035



SALIM
Group Of Industries

STAINLESS STEEL IMPRESSION TRAYS MADE OF 18/8 STAINLESS STEEL

English Pattern
Solid Full Denture Set of 8
786-225-036



786-1119
U0

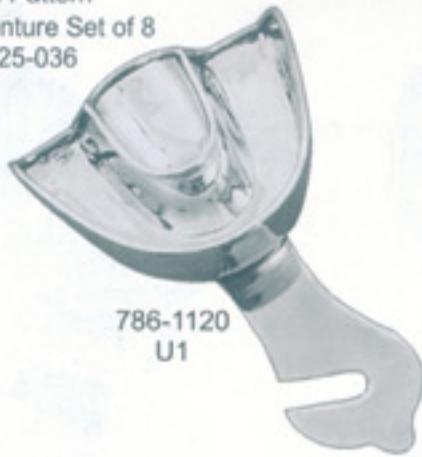

786-1120
U1



786-1121
U2



786-1122
U3



786-1119
L0

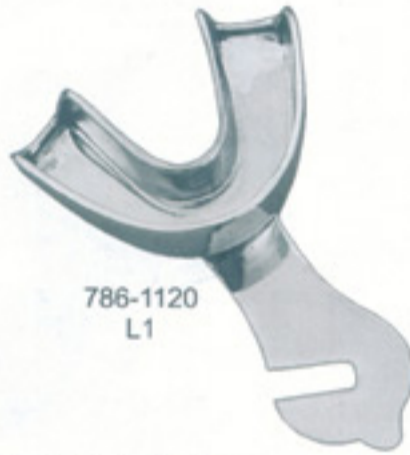

786-1120
L1



786-1121
L2



786-1122
L3

Upper 786zes 0,1,2,3,
Depth of the tray 15,9 mm
Height of palate 12,5 mm

Lower 786zes 0,1,2,3,
Depth of the tray 12,9 mm



786-1123
U0

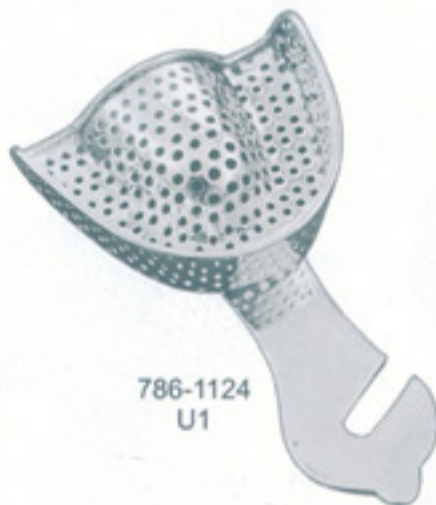

786-1124
U1

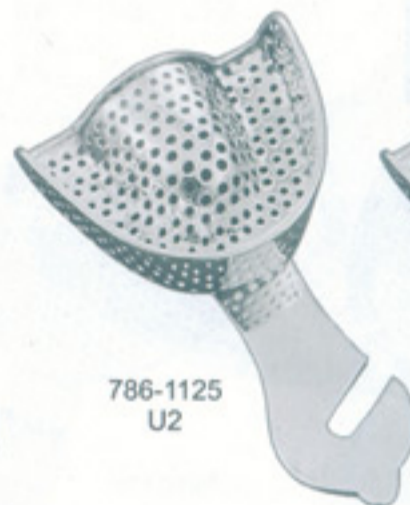

786-1125
U2



786-1126
U3



786-1123
L0



786-1124
L1



786-1125
L2



786-1126
L3

Perforated Full Denture Set of 8
786-225-043

STAINLESS STEEL IMPRESSION TRAYS MADE OF 18/8 STAINLESS STEEL

Impres trays for crown & bridge work



786-1127
U1P



Solid

786-1127
L1P



786-1128
U1P



Perforated

786-1128
L1P

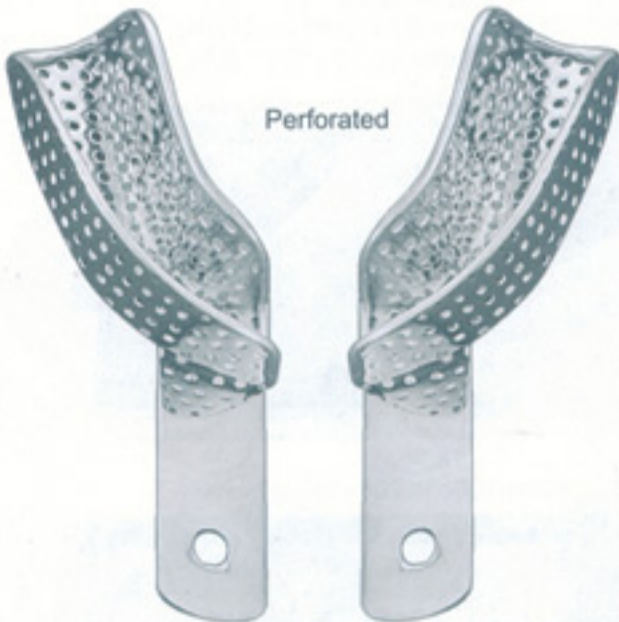

Perforated

786-1129
For upper right jaw
For lower left jaw

786-1130
For upper left jaw
For lower right jaw



786-1131
Adjustable
Perforated



786-1131A
Adjustable
Solid

Available in 4 786zes

- 1..... 44 mm
- 2.....55 mm
- 3.....60 mm
- 4.....65 mm

Also available in Solid pattern



SALIM
Group Of Industries

STAINLESS STEEL INSTRUMENT TRAYS MADE OF 18/8 STAINLESS STEEL

786-1132/01

Complete instrument tray with perforated base,
lid & insert frame for 16 instrument



786-1137/02

Complete instrument tray with perforated base,
lid & insert frame for 23 instrument



786-1132

Lid; dimen786ons mm,288x187x29

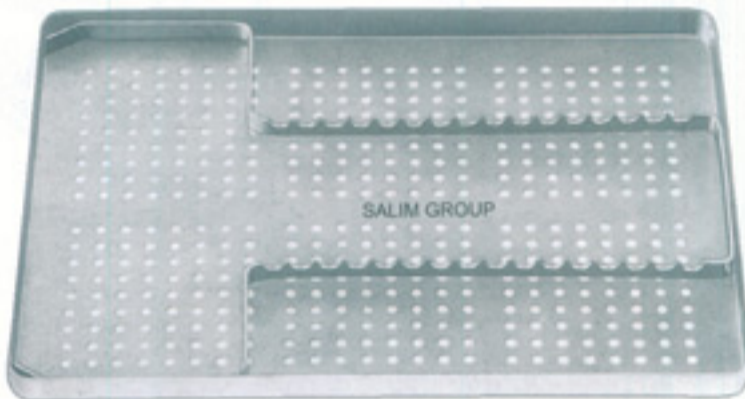

786-1136

Lid; dimen786ons mm,288x187x29

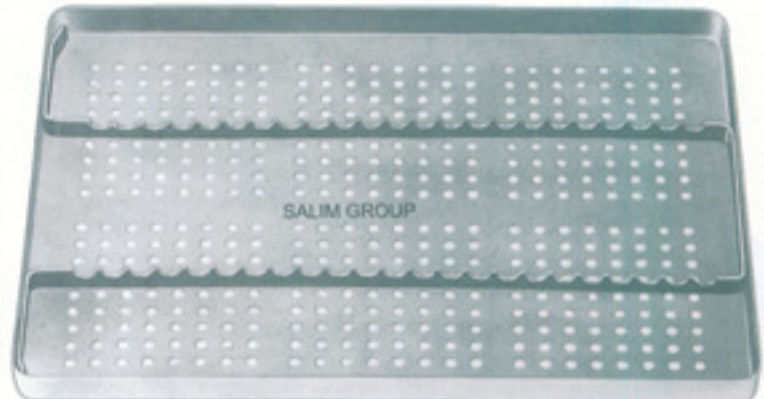

786-1133

Perforated base; dimen786ons 284x183x17 mm

786-1125/03

Complete instrument tray with solid base,
lid & insert frame for 16 instrument



786-1137

Perforated base; dimen786ons 284x183x17 mm

786-1139/04

Complete instrument tray with solid base,
lid & insert frame for 23 instrument



786-1134

Lid; dimen786ons 288x187x29 mm

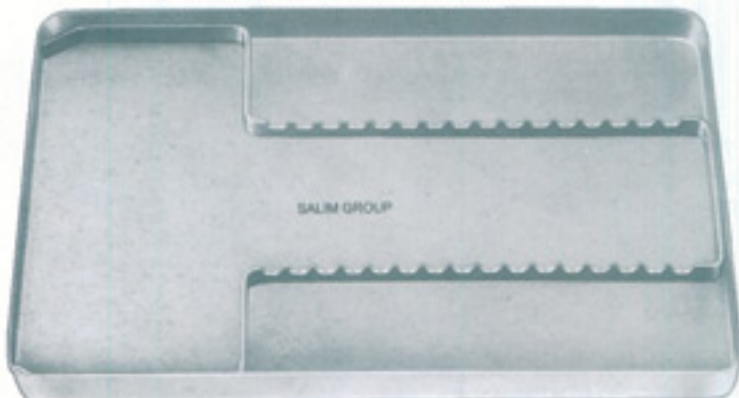

786-1138

Lid; dimen786ons 288x187x29 mm

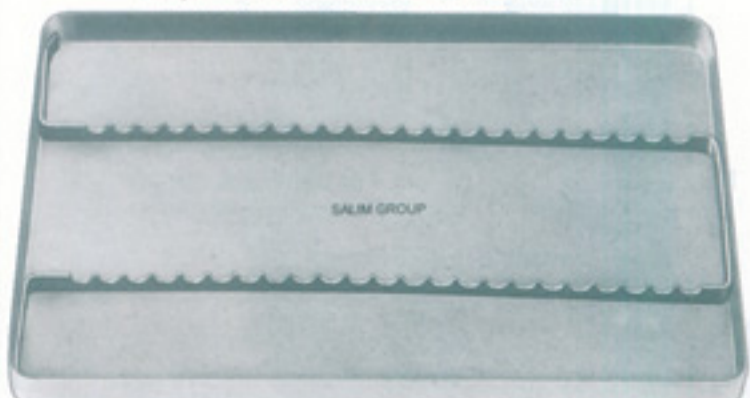

786-1135

Solid base; dimen786ons 284x183x17 mm

786-1139

Solid base; dimen786ons 284x183x17 mm

STAINLESS STEEL INSTRUMENT TRAYS MADE OF 18/8 STAINLESS STEEL

Scalers Tray



786-1140



786-1141
6" x 10"
without lid



786-1142
6" x 8"
with lid



786-1143
6" x 8"
8" x 10"
10" x 12"
with lid



786-1144

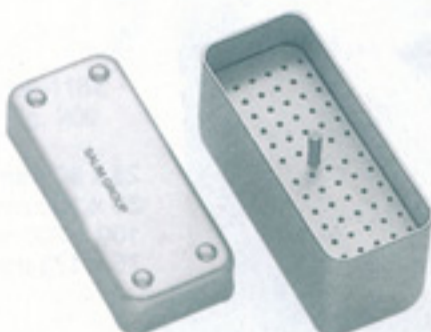

786-1145
Endodontic box
Also available in Solid pattern



786-1146
8" x 12"
with lid



SALIM
Group Of Industries

HOLLOWWARE MADE OF 18/8 STAINLESS STEEL



786-1147

2.25" x 2"
4.75" x 2"
5.5" x 2.5"
6.25" x 2.75"
7" x 3.5"

Deep



786-1149
6" x 9" - 8" x 12"

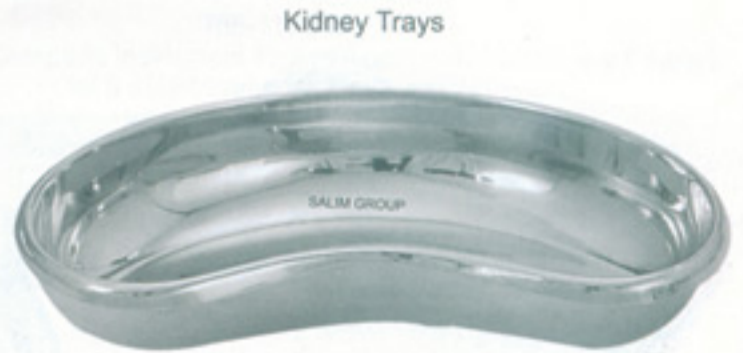

Kidney Trays

786-1148
12"-10"- 8"- 6"

Shallow



786-1150
10" x 10"

Round bowls



786-1151
Cotton holder



786-1152

80x35 mm
125x60 mm



786-1153
Spirit lamp



786-1154
Spirit lamp



786-1155
Forcep Jar

25 x 80 mm
30 x 100 mm
100 x 200 mm
75 x 173 mm

RUBBER DAM CLAMPS

SALIM
Group Of Industries



Molar Clamps Winged



786-1156
Fig. 30



786-1157
Fig. 31



786-1158
Fig. 51



786-1159
Fig. 138



786-1160
Fig. 139



786-1161
Fig. 15



786-1162
Fig. 18



786-1163
Fig. 24



786-1164
Fig. 25



786-1165
Fig. 26



786-1166
Fig. 28

Bicuspid Clamps Winged



786-1167
Fig. 206



786-1168
Fig. 207



786-1169
Fig. 208



786-1170
Fig. 209



786-1171
Fig. 22



786-1172
Fig. 27



786-1173
Fig. 29

Molar Clamps Winged



786-1174
Fig. 26A



786-1175
Fig. 28A



786-1176
Fig. 30A



786-1177
Fig. 31A



786-1178
Fig. 51A



786-1179
Fig. 27



786-1180
Fig. 29



786-1181
Fig. 60

Bicuspid Clamps Winged



786-1182
Fig. 200



786-1183
Fig. 201



786-1184
Fig. 202



786-1185
Fig. 203



786-1186
Fig. 204



786-1187
Fig. 205

Molar Clamps Winged

Labial Clamps Winged



786-1188
Fig. 210



786-1189
Fig. 211



786-1190
Fig. 212



SALIM
Group Of Industries

**HOLLOWARE
MADE OF 18/8 STAINLESS STEEL**

INSTRUMENTS TRAYS



(255x165x18mm)
(385x265x16mm)
(485x320x16mm)

786-1191
Mayo Tray/Utility Tray/Dental Tray



786-1192
Catheter Tray with Lid
200x75x35
210x115x45
400x70x50

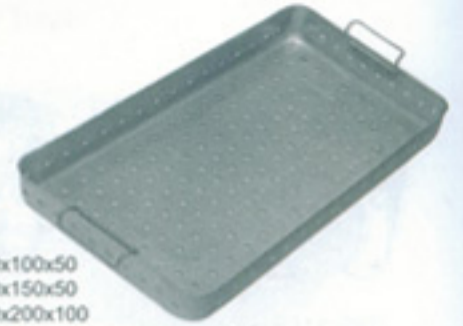

200x100x50
300x150x50
400x200x100

786-1193-Perforated Tray



200x100x50mm
300x150x50mm
400x200x100mm

786-1194
Instruments Tray with Lid / Without Lid

INSTRUMENTS BOXES



180x75x40
200x100x50
500x210x120

786-1196
Instrument Box with Cover & Hooks



140x80x40
200x100x50

786-1197
Instrument Box Perforated



786-1195
Instruments Tray



180x75x40
200x100x50
500x210x120

786-1198
Instrument Box with Cover

BED PANS



370x290
320x240
480x300

786-1199
Bedpan, Slipper Type with Cover & Handle



(Adult)
(Child)

786-1200
Bedpan, Simple Pressed Body
With Handle



(Adult)
(Child)

786-1201
Bedpan Hand Made



370x290
320x240

786-1202
Bedpan Perfection Type(Seamless)



(Adult)
(Child)

786-1203
Bedpan Round with Cover & Handle



370x290
320x240

786-1204
Bedpan Perfection Type

**HOLLOWARE
MADE OF 18/8 STAINLESS STEEL**

KIDNEY TRAYS



786-1205
Kidney Tray Shallow Type 200
250

786-1206
Kidney Tray Traditional 120
200
250

786-1207
Kidney Tray with Lid 200

URINAL POTS



786-1208
Urinal Female

786-1209
Urinal male Horizontal (UNICEF)

786-1210
Urinal male Vertical

STERILIZERS / BOILERS

786-1211
Sterilizing Drum

150x150
200x200
240x240
340x340



786-1212
Instruments Boiler with Lid, Perforated
Internal Tray & Hook

140x80x40
200x100x50



786-1213
Electric Sterilizer /Boiler
With Hook & Stand

200x100x50
250x125x50
320x120x50



786-1214
Electric Sterilizer /Boiler

320x100x50
250x125x50
320x120x50



SALIM
Group of Industries

**HOLLOWWARE
MADE OF 18/8 STAINLESS STEEL**

JARS



80x60
120x120
180x180

786-1215
Dressing Jar



786-1216
Forceps Jar
50x125
50x170
80x150



80x60
120x120
180x180
786-1217
Dressing Jar

786-1218
Needle Case Rectangle

786-1219
Needle Case Round



90x15

786-1220
Needle Case Round
with Cover



90x15

**TUBE RACK
&
NEEDLE CASES**

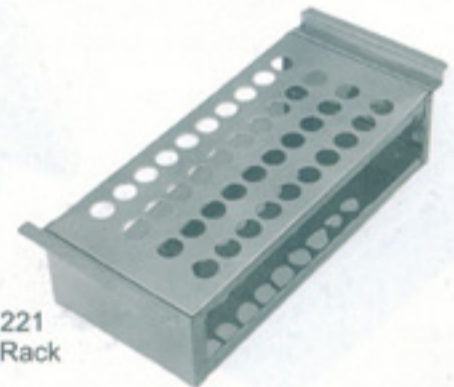

786-1221
Tube Rack

WASH BASINS / BOWLS



786-1222
Sponge Bowl



786-1223
Wash Basin
300
350
400



786-1224
Lotion Bowl without Spout/Lip
60
120
200



280x380x200
786-1225
Kick Bucket with Trolley

HOLLOWWARE MADE OF 18/8 STAINLESS STEEL

MISC



786-1226
Sputum cup
Spitten Mug 100x50



786-1227
Sprit Lamp 50 cc
100 cc



786-1228
Fennle 200



786-1229
Gallipots 3 oz
6 oz
8 oz



786-1230
Fetal Scope
15 cm



786-1231
Medicine Cup
Iodine Cup



786-1232
210mm 240mm 270mm 300mm



786-1233
Cotton Holding Jar 60x50



786-1234
Measuring Jug 0.5 Liter
1.0 Liter



786-1235
Bucket with Lid & Cap 6 Liter
10 Liter



786-1236
Enema Cane 1.0Liter
Douch Can / Irrigator 1.5Liter



SALIM
Group Of Industries

RUBBER DAM KIT ARTICULATORS

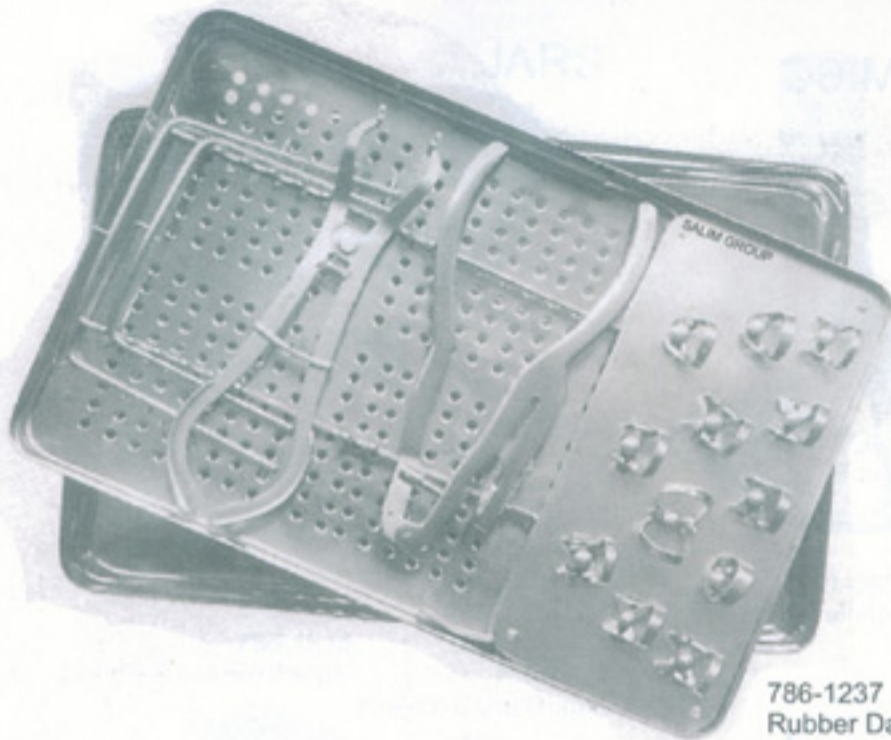

786-1237
Rubber Dam Kit



786-1238
Clamp Kit



786-1239



786-1240



786-1241



786-1242

ARTICULATORS



786-1243



786-1244



786-1245

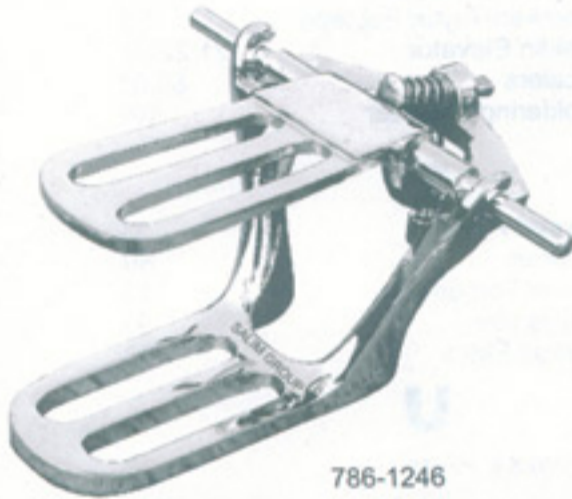

786-1246

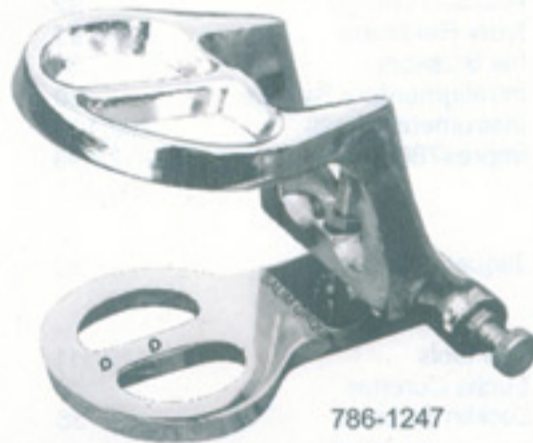

786-1247



786-1248

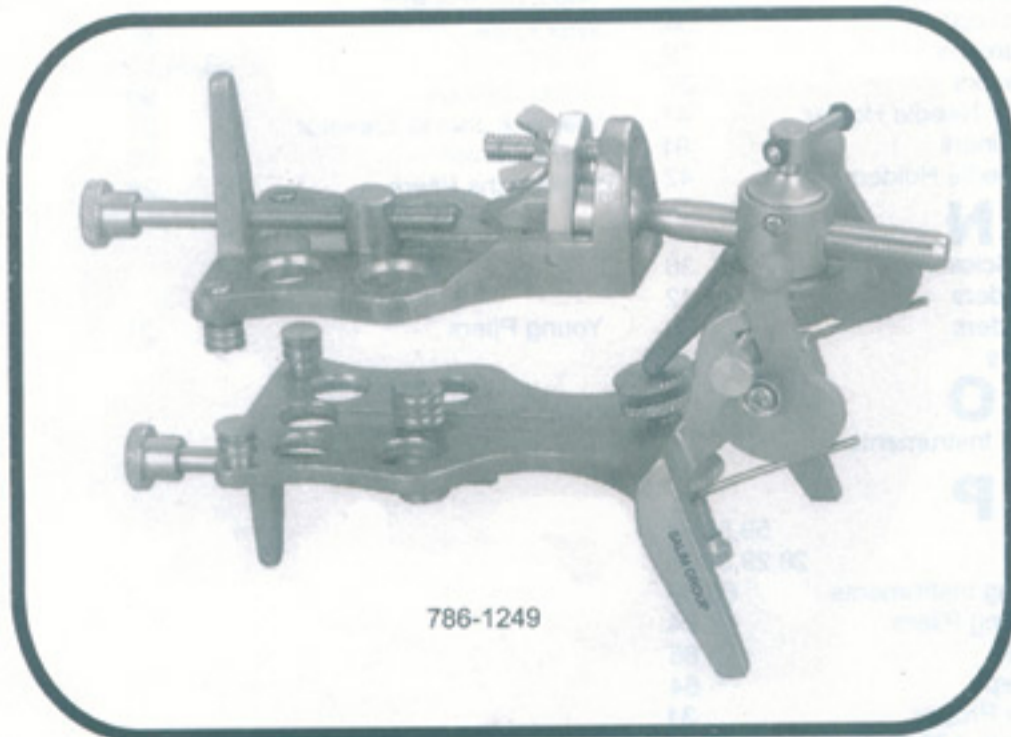

786-1249

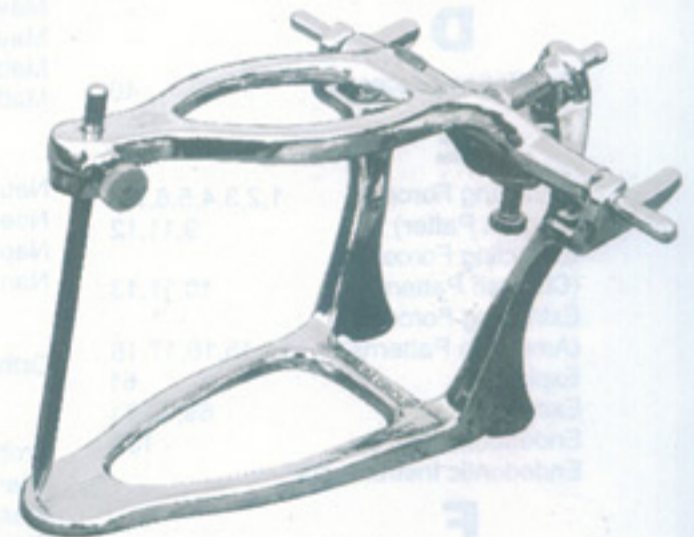

786-1250



SALIM
Group Of Industries

ALPHABETICAL INDEX

A

Aspirating Syringe	89
Arruga Needle Holder	42
Articulator	110,111
Apexo Root Elevator	21,22,23
Angular Scissors	34
Angle Pliers	30
Amalgam Carriers	88
Amalgam Well	88
Alm Retractors	47
Adson Forceps	53
Aderer Pliers	28,31
Adam Pliers	31

B

Bone Ronguers	20
Bone Files	73,74
Bone Curettes	75
Boley Gauge	92
Bien Elevator	21

C

Cryer Elevators	24
Crucible Tongs	110
Crown Scissors	92
Crown Removers	93
Crown Instruments	92,93,94
Crane-kplane Forceps	54
Coupland Elevators	25
Cotton & Dres786ng Pliers	54
College Forceps	54
Columbia Curettes	77
Cleoids-Discoids	67
Chisels	51
Chip Blower	90
Cheatle Forceps	43
Cement Spatulas	82
Castroviejo Scissors	36
Castroviejo Needle Holders	42
Carvers	66,67
Cartridge Syringe	89

D

Dres786ng Forceps	40
-------------------	----

E

Extracting Forceps (English Patter)	1,2,3,4,5,6,7,8
Extracting Forceps (Children Pattern)	9,11,12
Extracting Forceps (American Patterns)	10,11,13
Explorers	14,15,16,17,18
Excavators	61
Endodontic Box	69,70,71
Endodontic Instruments	103

F

Freer Retractor	44,45,46,47
Flohr Elevator	21
Flagg Forceps	54
Filling Instruments	62,63,64,65
Film Holder	90
Farabeuf	46

G

Gum Scissors	34,35
Goldman-Fox Scissors	34,35
Goldman-Fox Scalars	76,79
Ggoldman-Fox Exploers	61
Greafe Retractor	44
Gracey Curettes	78
Gillies Retractor	44

H

Holloware	106,7,8,9
How Pliers	29
Hollen Back	64,66
Heidmann Spatulas	82
Heidbrink Elevator	23
Heger-Olsan Needle Holder	41
Haemostatic Forceps	38,39
Handles For Scalpel Blades	56
Handle For Reference	57
Handles For Mouth Mirror	55

I

Iwanson Gauge	92
Ivory Retainers	91
Iris Scissors	34
Intraligmentary Syringe	89
Instruments Trays	102,103
Impres786on Trays	95,96,97,98,99
	100,101

J

Jaquette Curettes	80
-------------------	----

L

Lab tools	110-111
Lucas Curettes	75
Locklin Scissors	35

M

Mouth Mirror	55
Mosquito Forceps	38
Metzenbaum Scissor	37
Meriam Forceps	54
Mc Call Curettes	79
Mayo. Scissors	37
Mayo-Hegar Needle Holder	41
Matrix Retainers	91
Mathieu Needle Holders	42

N

Neumann Scissors	36
Needle Holders	41,42
Napkin Holders	90
Nance Pliers	28

O

Orthodontic Instruments	32,33
	106,107

P

Probes	59,60,61
Pliers	28,29,30,31
Plastic Filling Instruments	65,66
Plaster cutting Pliers	94
P.K.Thomas	85
Perry Forceps	54
Periodontia Probes	31
Periodontia Inst.72,74,76,77,78,79,80,81	
Peeso Pliers	30
Peen Forceps	38

R

Rubber Dam & Clamp kit	108
Rubber Dam Punch	52
Rubber Dam Frame	52
Rubber Dam Clamps Forceps	52
Rubber Dam Clamps	105
Root Elevator	21,22,23,24,25,26,27
Retractors	44,45,46,47
Raspatories	49

S

Surgical Scissors	36
Sterilizing Drum	104
Spreader	36
Splinter Forceps	19
Spirit Lamp	104
Spencers Scissors	36
Spatulas For Plaster	87
Siqveland Wide	91
Siqveland Narrow	91
Semken-Taylor Forceps	53
Seldin Elevator	21,22,23
Scalars	80,81
Soldering Tweezer	109

T

Tweed Pliers	31
Towner	80
Towel Forceps	43
Tofflemire	91
Tissue Pliers	53

U

Universal Pliers	28
------------------	----

W

Woodson	66
Wire Bending Pliers	31
Williger Retractor	48,49
Westcott Scissors	36
Wax Knife	86
Wax Carver	83,84,85
Water Syringe	90
Warwick James Elevator	27
Ward Carver	66
Waldsachs Pliers	28

Y

Young Pliers	31
--------------	----

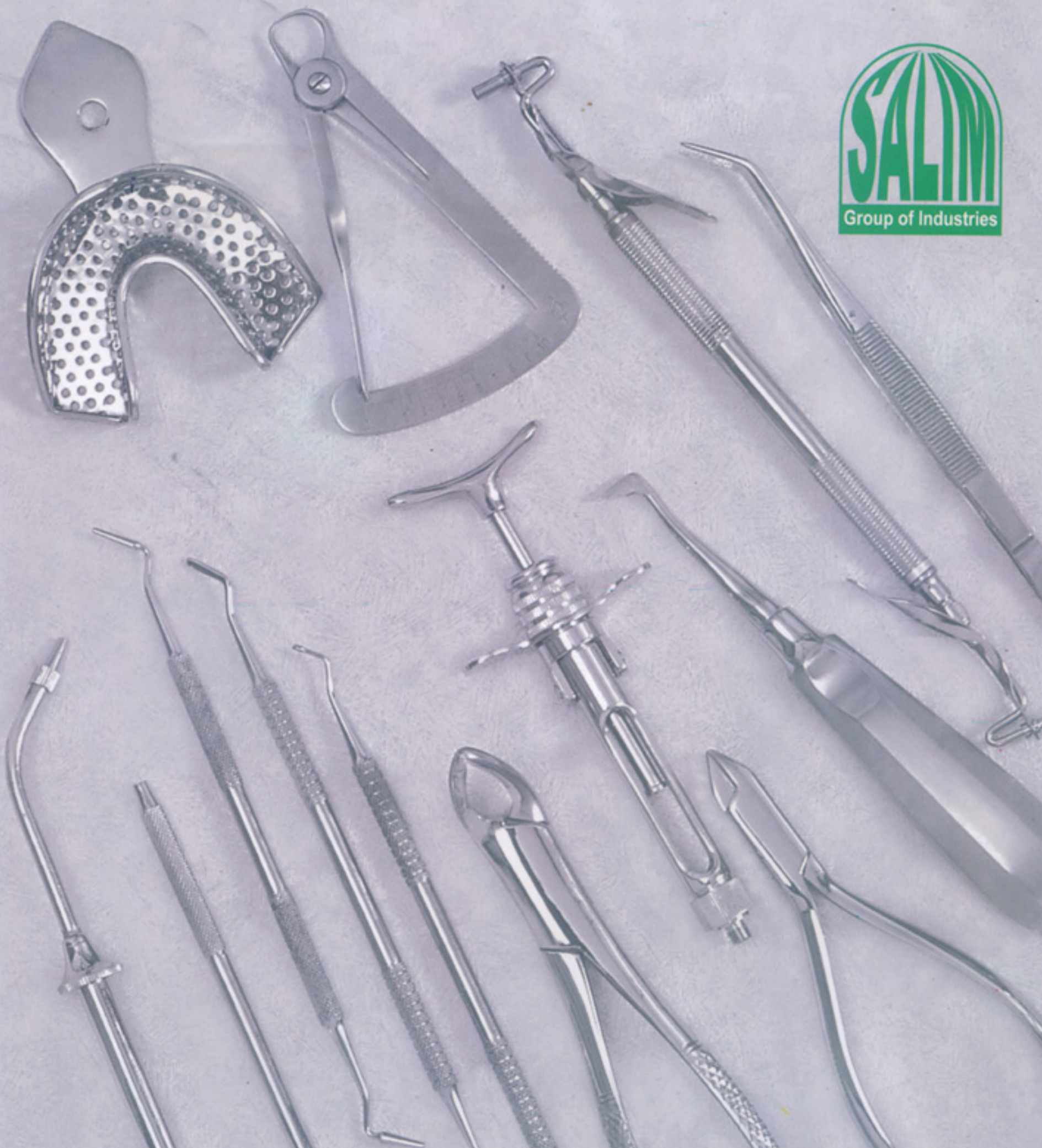

www.salim-group.com



ISO 9001:2000

CERTIFIED
GMP(FDA)USA

CE MARK